

ATELIER FREI OTTO
WARMBRONN
LEONARDO
07152 41084 (43006)

Hooke forest acquired
end of 70s.
design team put together
as choice of site 81-82
master plan 1983
House (prototype) 1985-6
Workshops 1988-89
ABK + Frei Otto resigned
1991.

Cullinan - Happold continue
New master plan (not used)
Westminster Lodge
Cullinan resigned.

New architects
another master plan (not used)

AA. acquired Hooke
2002-3

1981-82

This book got the show on the
road. In it are most of the ideas we used except
the joints
Frei Otto based all his skidlines on this
basis of the economic use of materials.

note by Feb. 2006.

HOOKE PARK

A FIRST COLLECTION OF IDEAS
FOR THE USE OF WET TIMBER

BY ATELIER FREI OTTO
FOR MR. JOHN MAKEPIECE
AHRENS, BURTON AND KORALEK, ARCH.
BÜRO HAPPOLD ENG.

WARMBRONN,

25. 8. 1982

CONTENTS :

GROWTH AND SHRINKING OF WOOD

FOUNDATIONS

CONNECTORS

FLOORS

WALLS

ROOFS

SCELETON AND FRAMEWORK

SHELLS

TENTS

SPECIAL HOUSETYPES

PAGE

3

9

14

27

33

44

48

58

64

73

07152-41084 (43000)

19

BERG AL

7250 LEONBERG

ATELIER FREI OF

GROWTH AND SHRINKING
OF WOOD

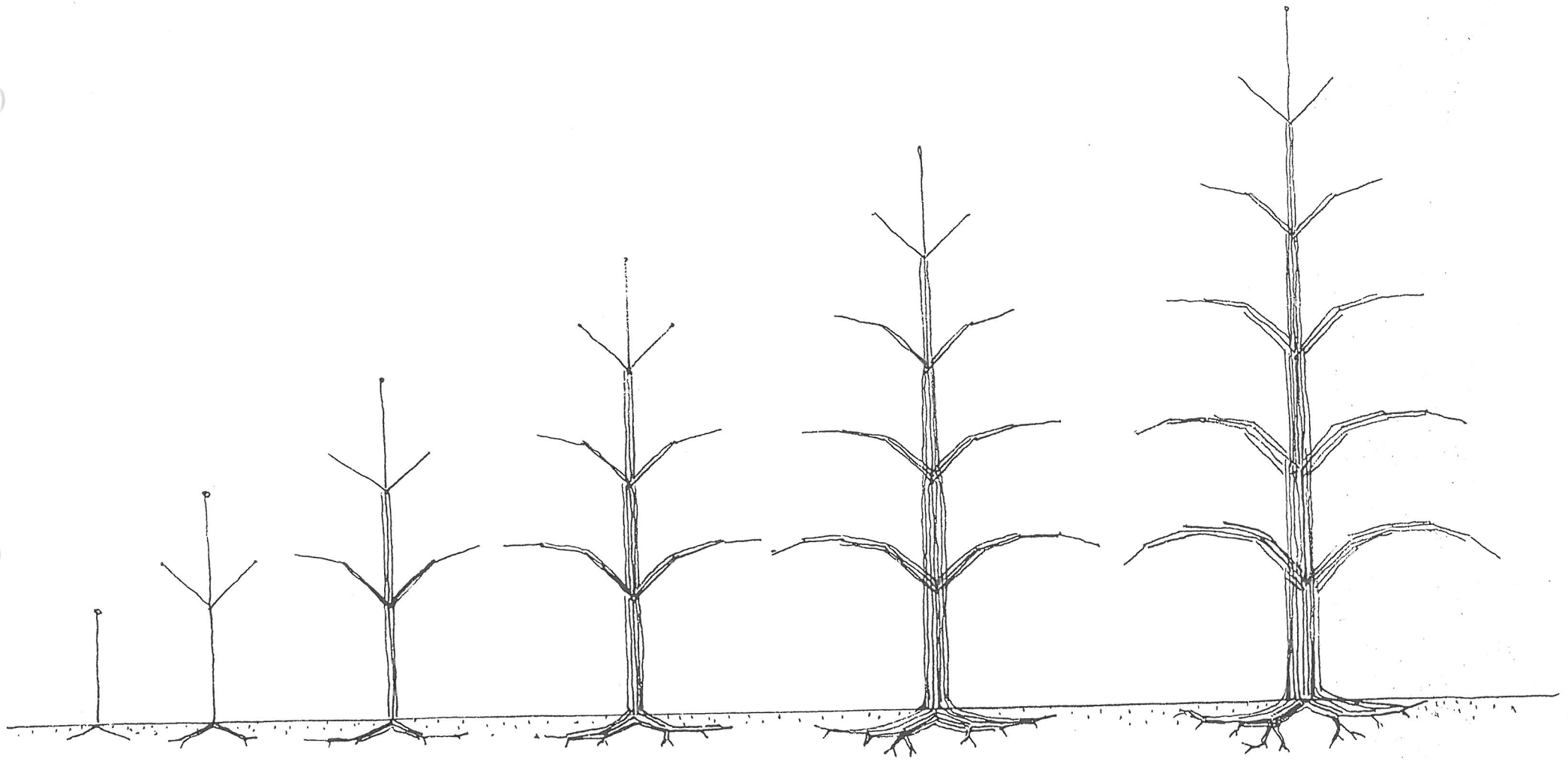

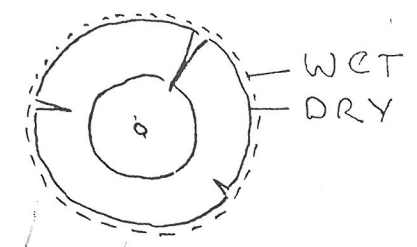
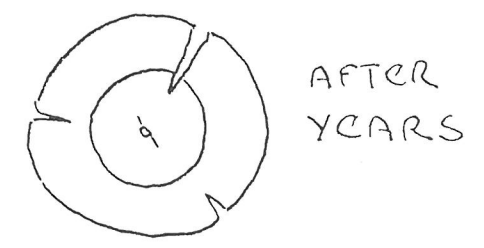
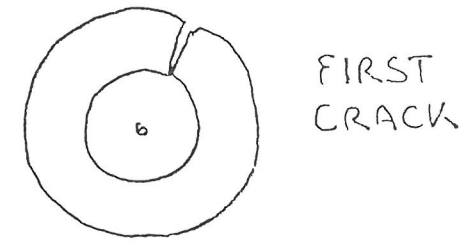
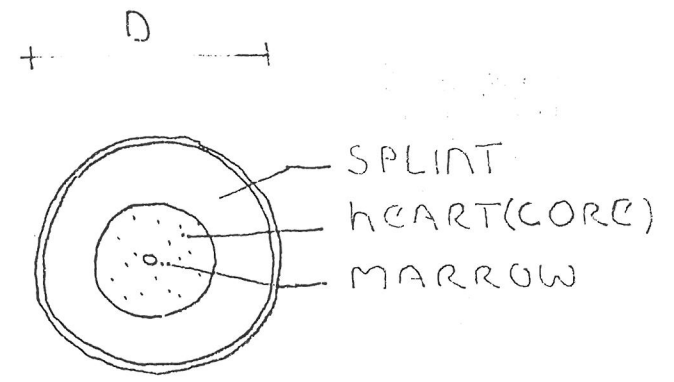

SHRINKING OF WOOD (t)

TOTAL THICKNESS D
BETWEEN 7 - 15 CM
CONIFER WOOD

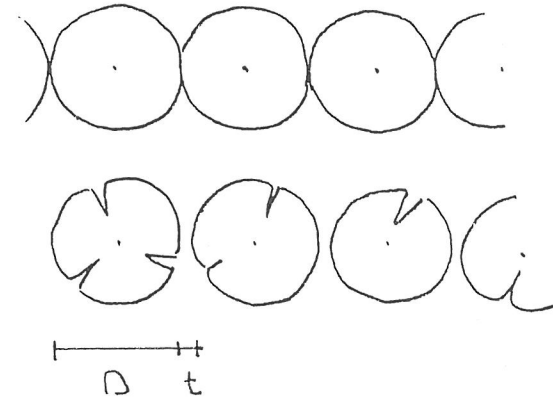

$$t \approx 1/15 \text{ to } 1/25 \text{ OF } D$$

OPENING OF JOINTS IN RELATION
TO SHRINKING

NOT THROUGH THE SPLINT
WORKS LIKE AN EXPANSION JOINT -
AVOIDS CRACKS

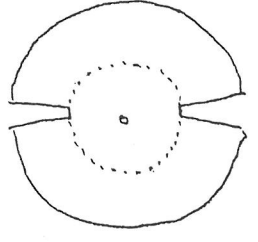
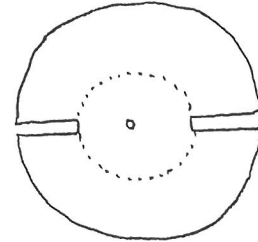
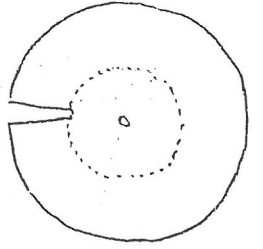
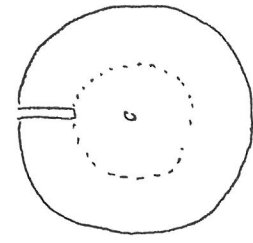

FOUNDATIONS

CONCRETE
FOUNDATION
FOR PILES OF TIMBER

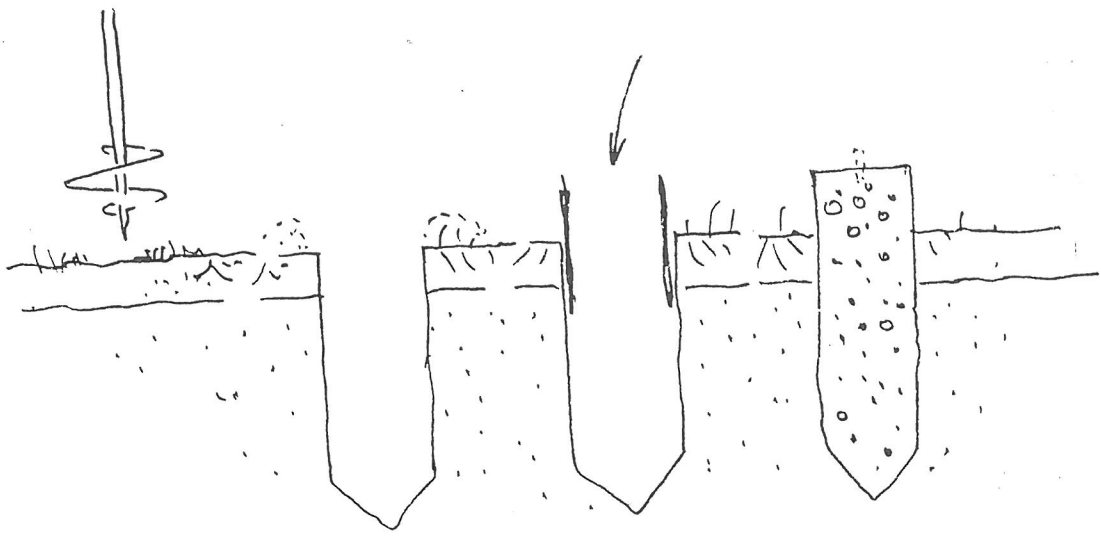

'SAND POT'
ADJUSTABLE FOUNDATION
FOR COLUMNS, TENTMASTS,
ECT.

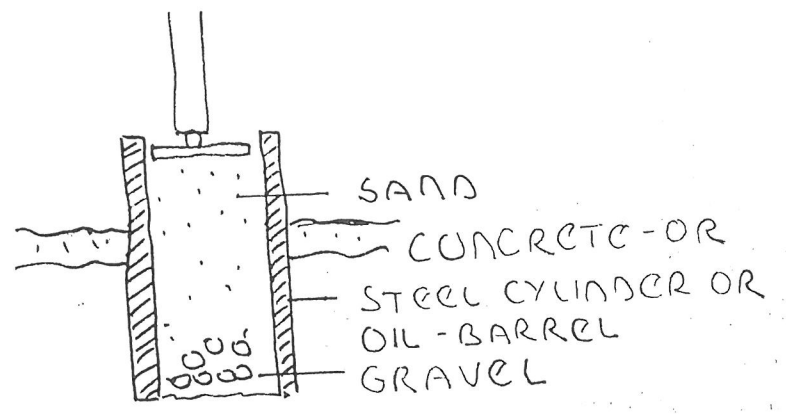

ATELIER FRIE OTTO
DAN - 7250 LEONBERG 7 BERGH
07152 - 41084 (43008)

ATELIER FREI OTT
BRONN - 7250 LEONBERG 7
BERG
19
07152 - 41084 (43008)

FOUNDATIONS FOR HORIZONTAL BEAMS

TIMBER OR STONE

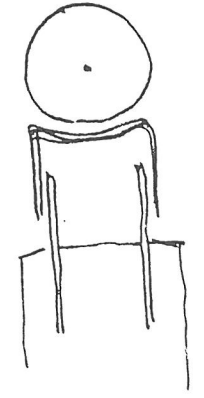
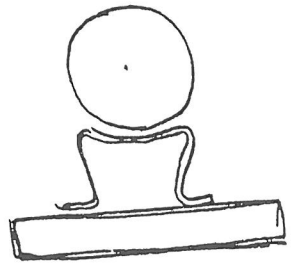
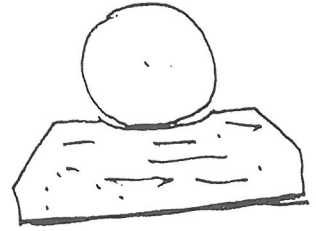

WOODEN TRUNK

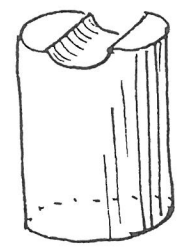

ZINC COATED STEEL

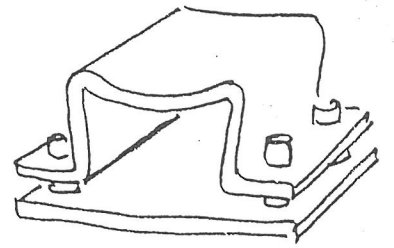
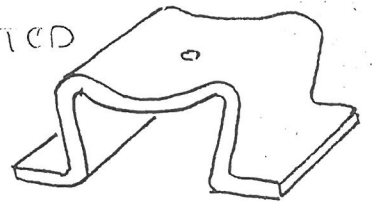

STEEL PLATE WITH THORN
FOR PILE

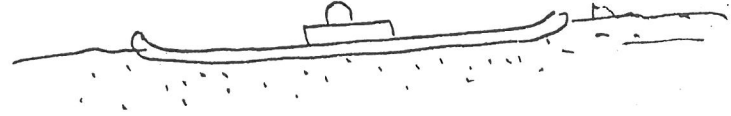

STONE SLABS ON GRAVEL
FOR WALL

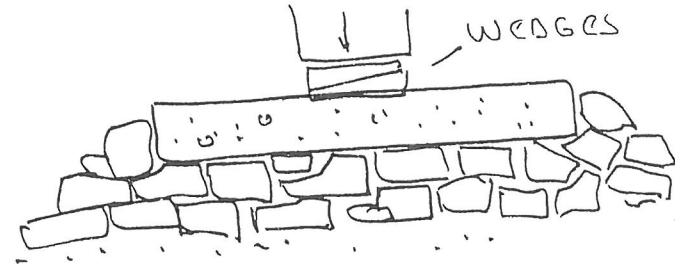

CONCRETE FOUNDATION STRIP
FOR WALL

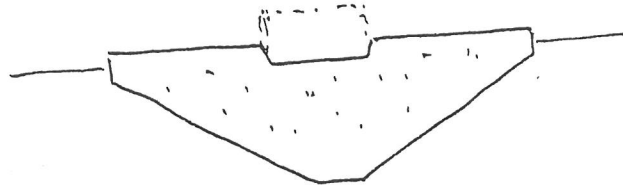

RAILWAY SLEEPERS ON GRAVEL

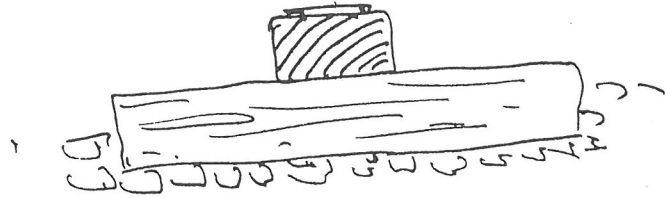

STEEL SHOES

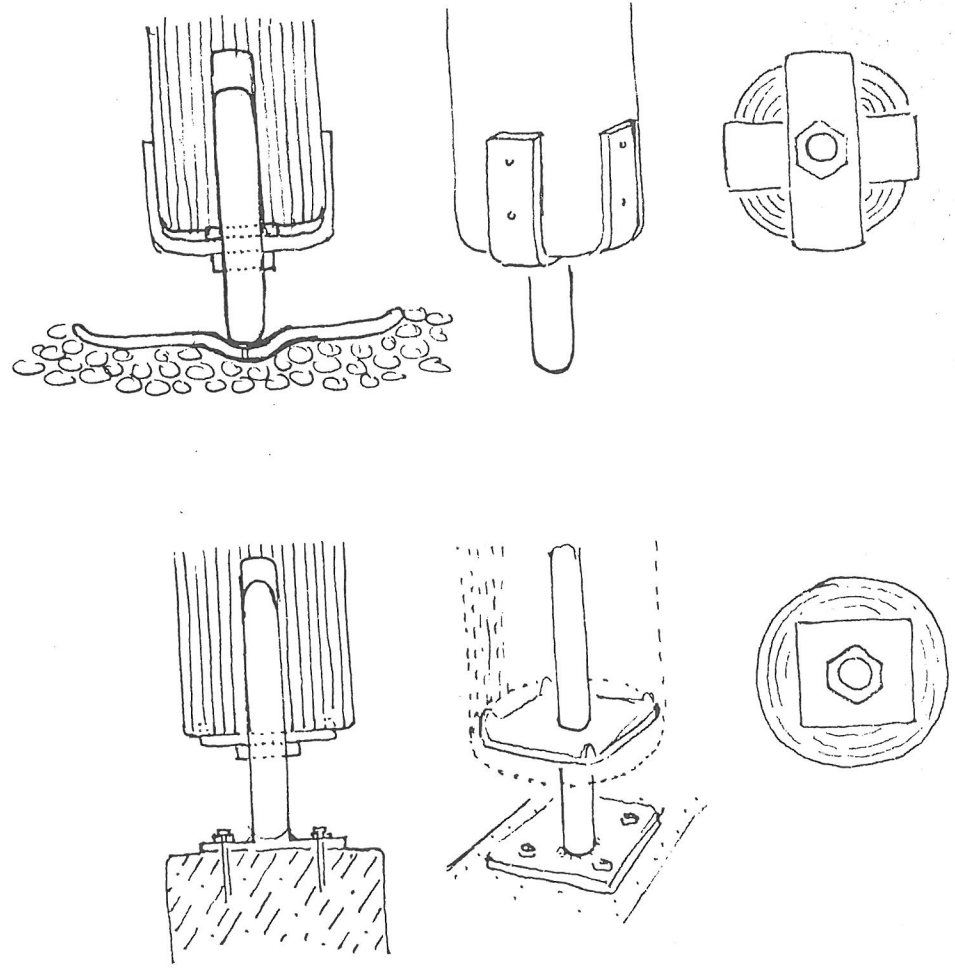

ATELIER FREI OTI

102 10

BERG

7250 LEONBERG 7

WARMBRONN

07152 - 41084 (43908)

CONNECTORS

NAILS AND BOLTS

TIMBER NAIL

PLASTIC COATED
STEELNAIL

STEELNAIL

STEELNAIL WITH
WINDING

SCREW

SCREW BOLT

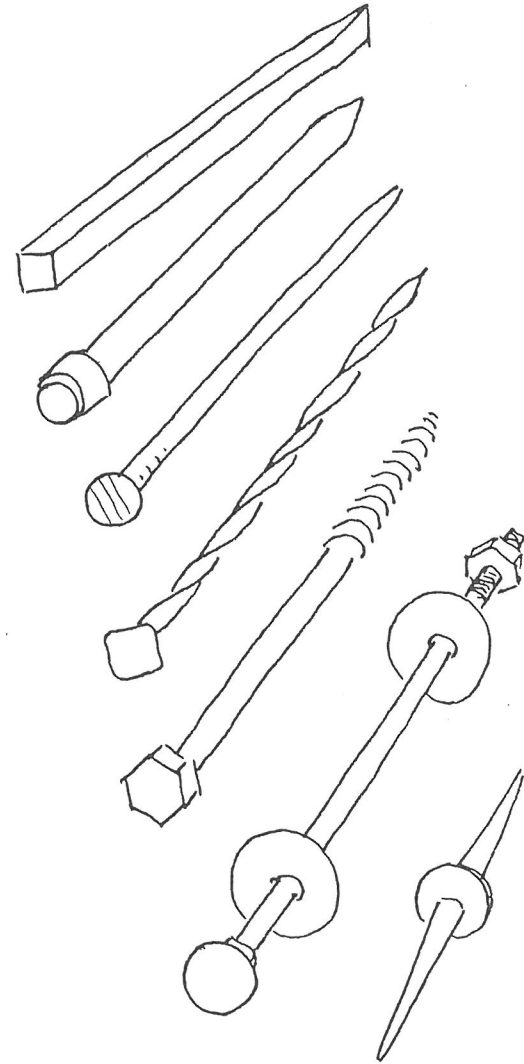

NAIL WITH 'SPRINGHEAD'
(TO ALLOW FOR SHRINKING)

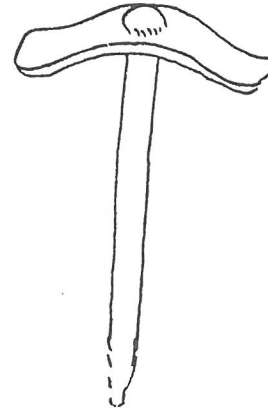

SCREW BOLT
WITH SPRING WASHER

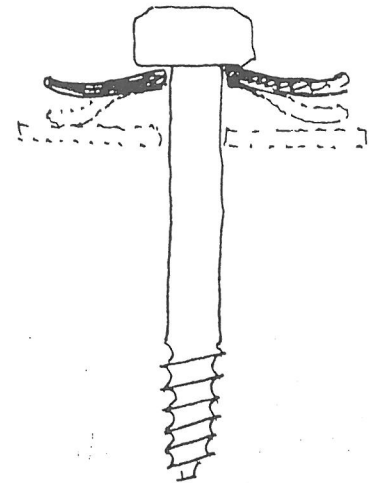

BOLTS WITH SPRINGWASHERS
DURING SHRINKING PROCESS

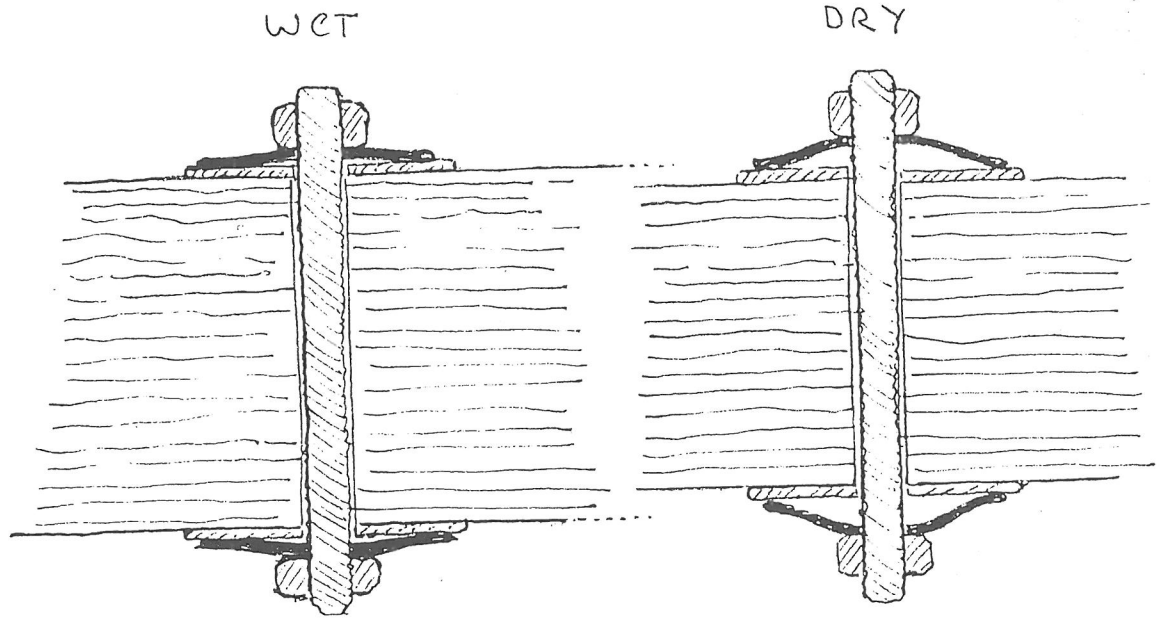

NAIL PLATES

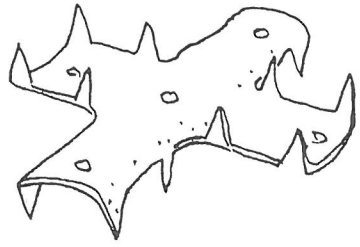
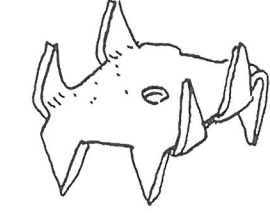
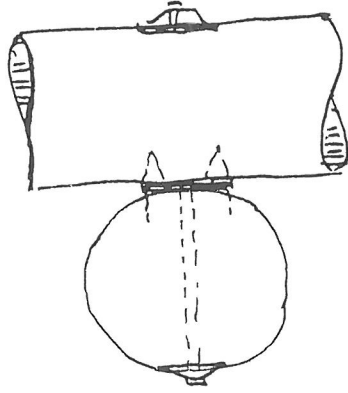

STEEL CLAMP

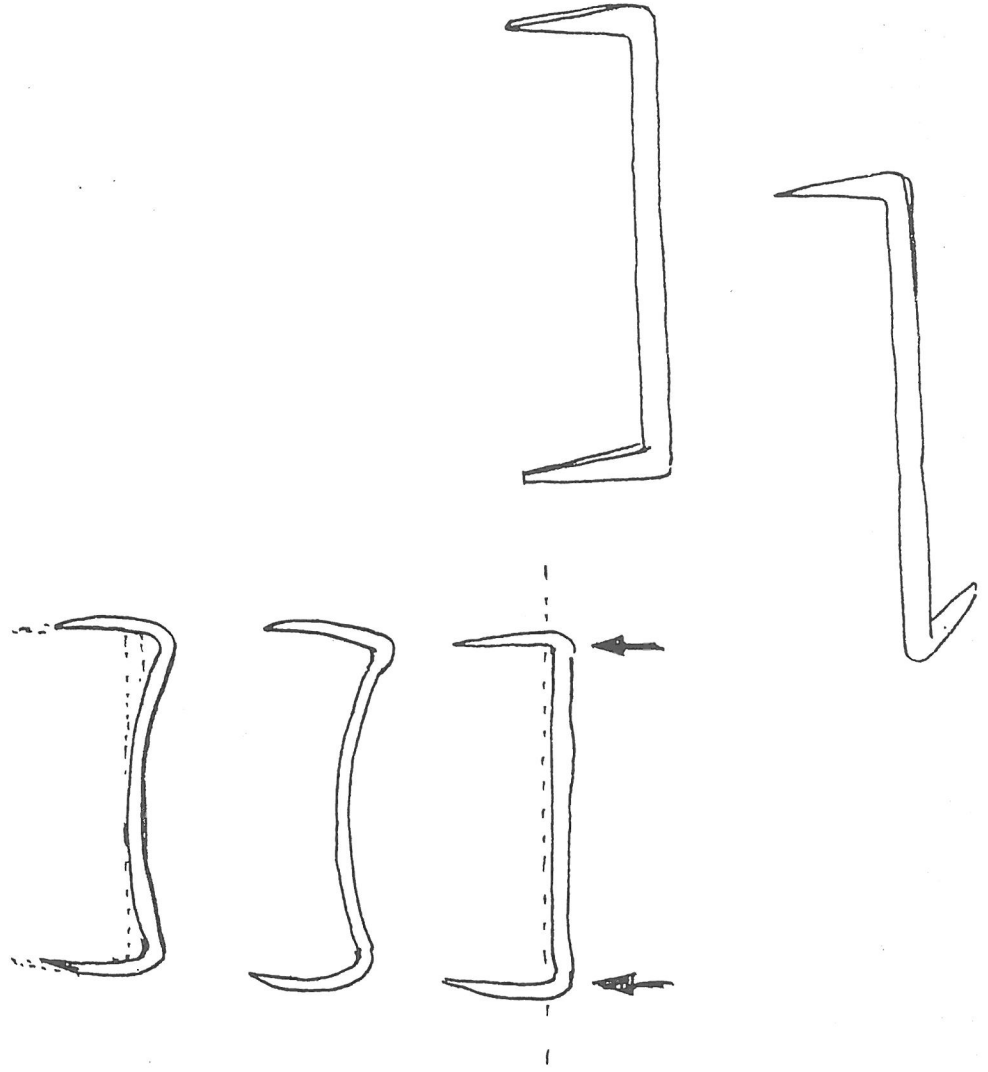

STRING CONNECTORS

ROPES (HIGH ELASTICITY, NYLON
PERLON, OR SELF SHRINK-
ING HANF)

WIRES OR THREADS

SPRING WIRES

FLAT SPRINGS

METAL BAND

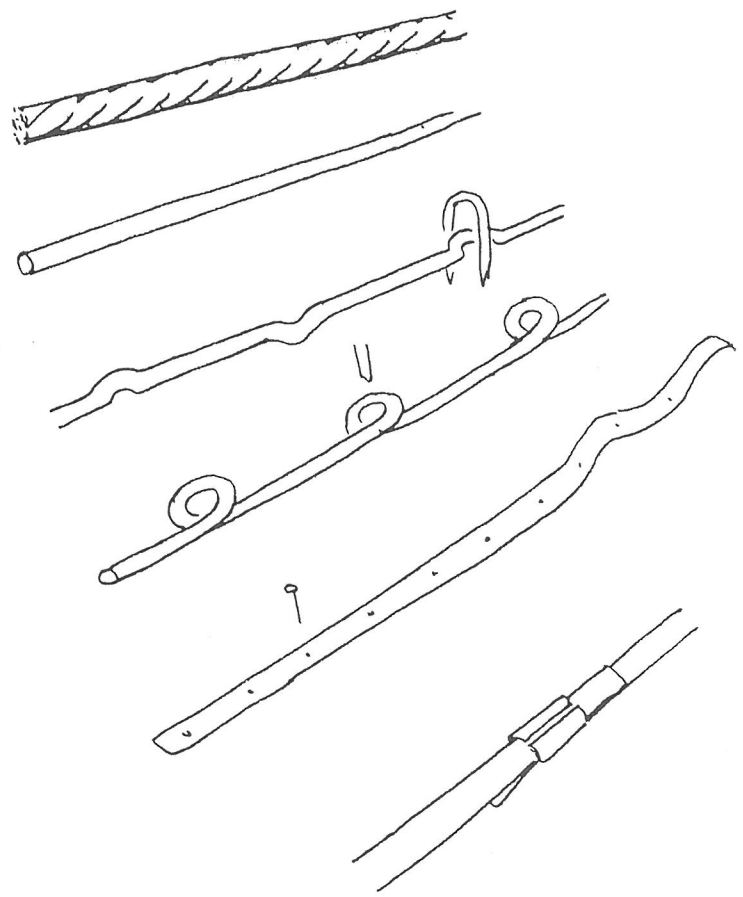

METAL STRIP

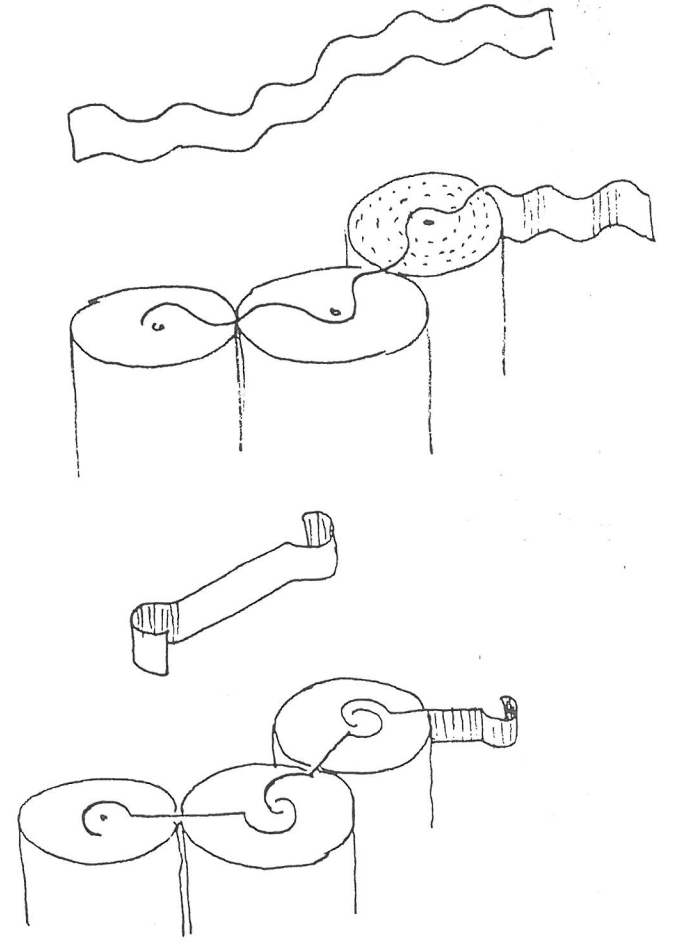

STRING CONNECTIONS

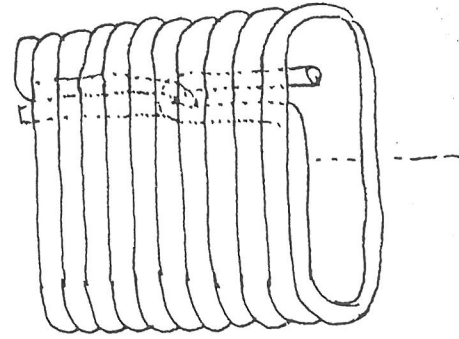

FOR 2 PARALLEL BEAMS

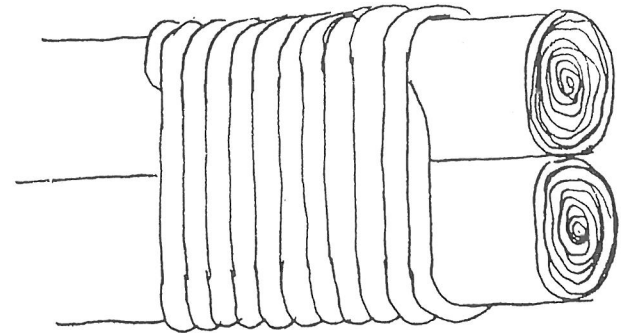

STRING CONNECTIONS
FOR SEVERAL PARALLEL
BEAMS

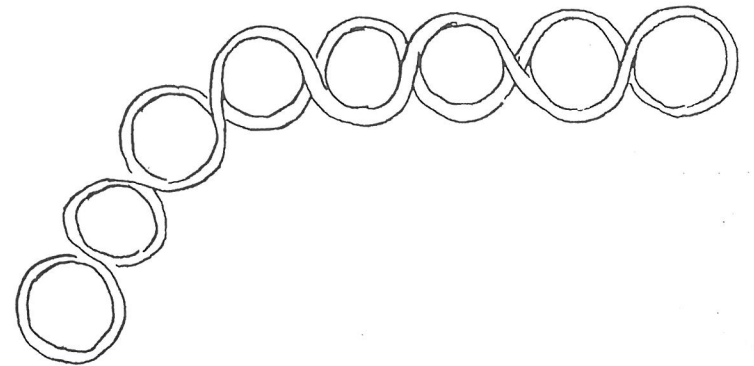
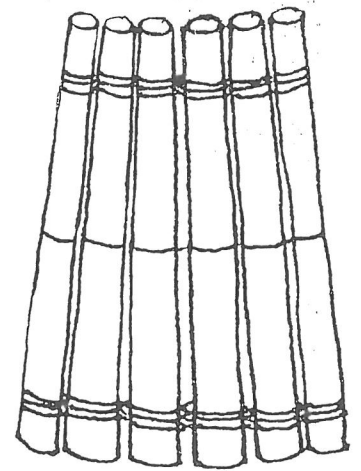
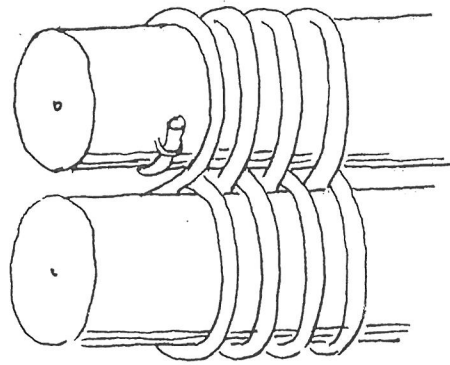

STRING
CROSS -
CONNECTION

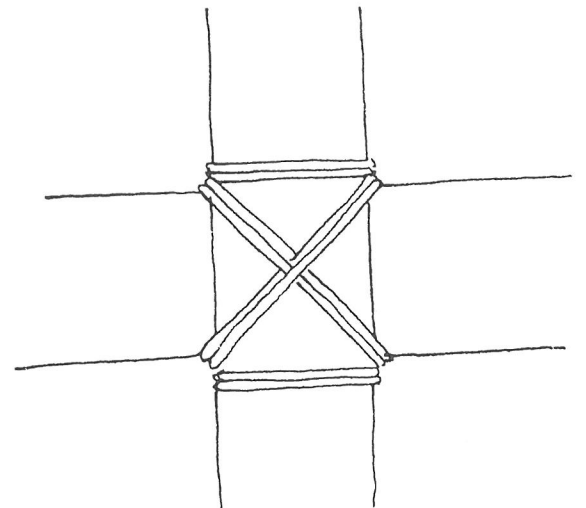
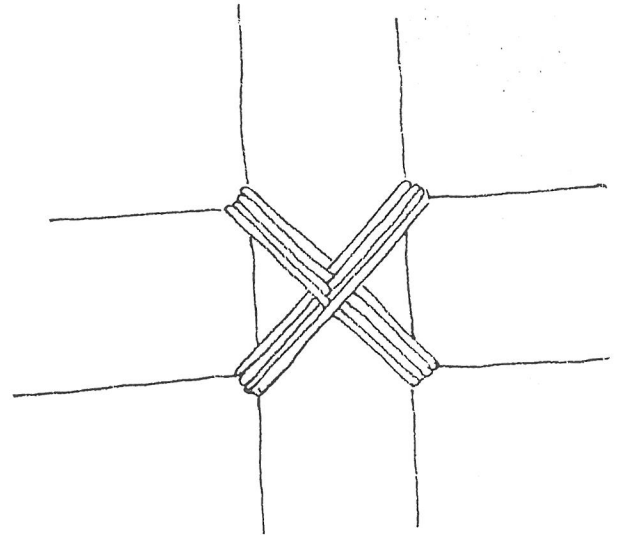
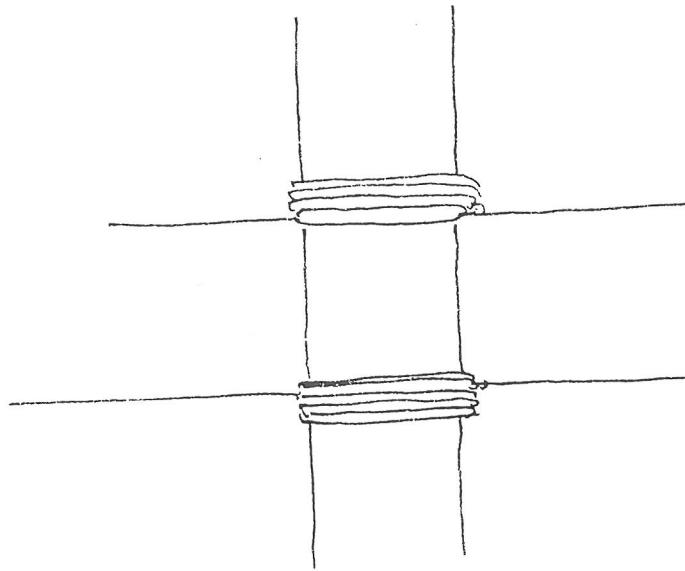

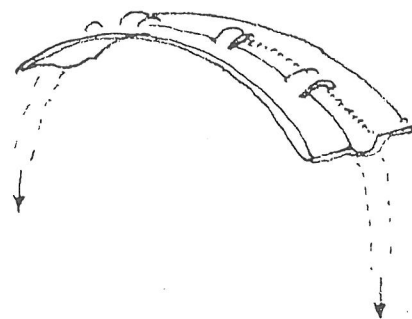
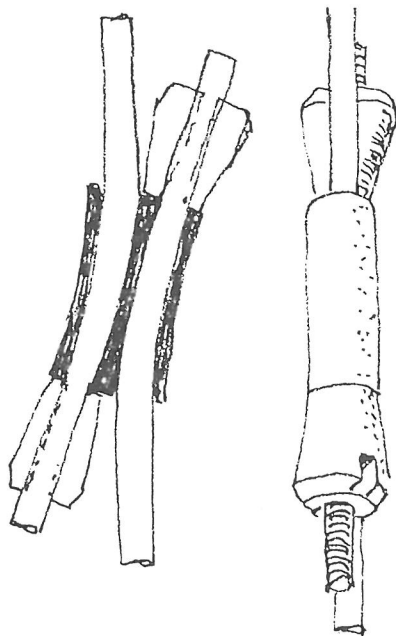
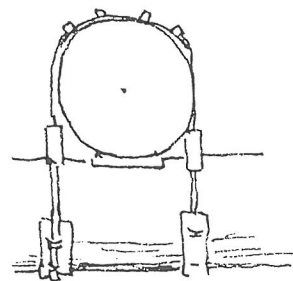
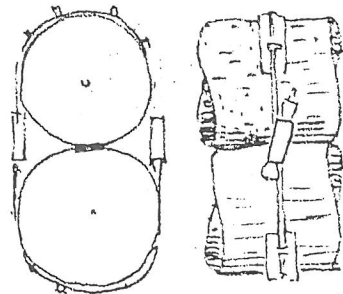

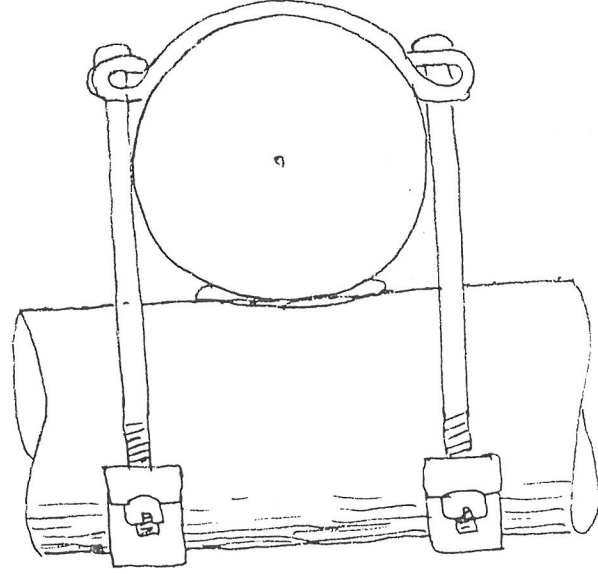
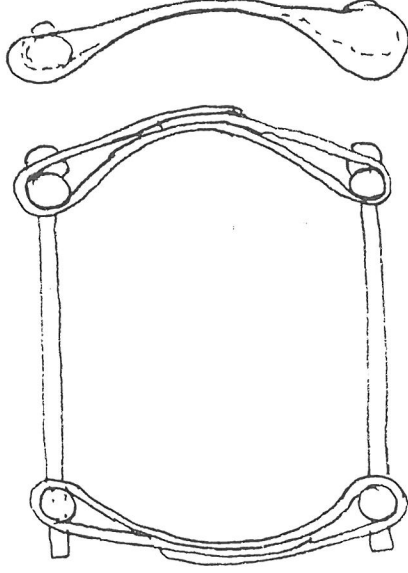
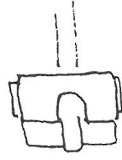
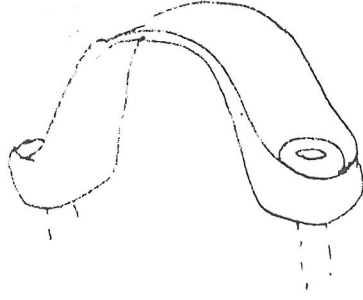
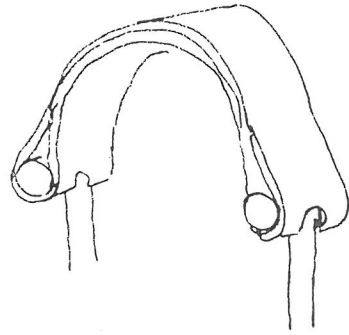

F 07152 - 41084 (43908)

BERG 1000 19

7250 LEONBERG 7

ATELIER FROLOT MARMIERON

FLOORS

STÄBCHEN WIRE

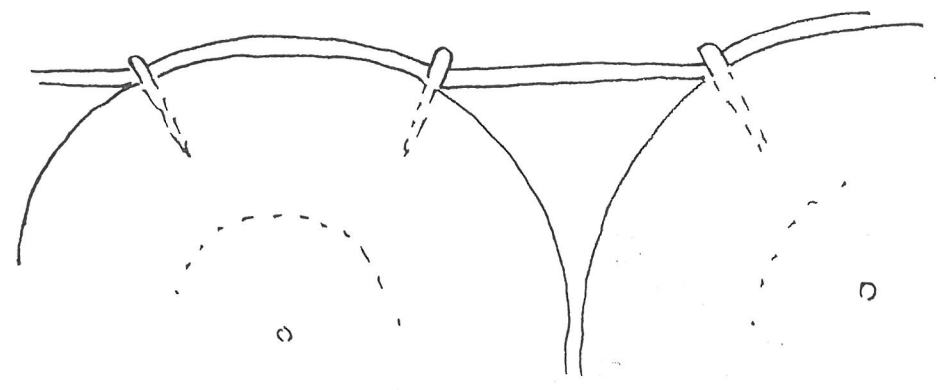
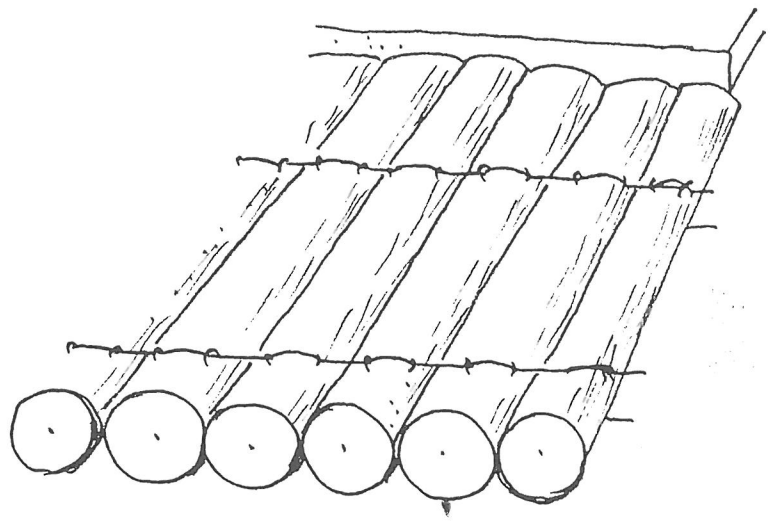

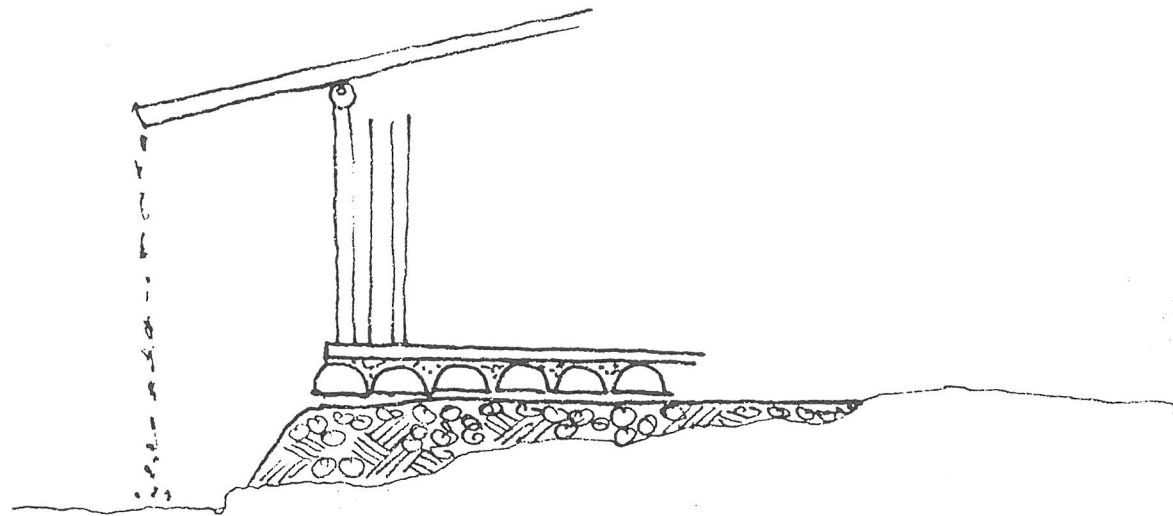
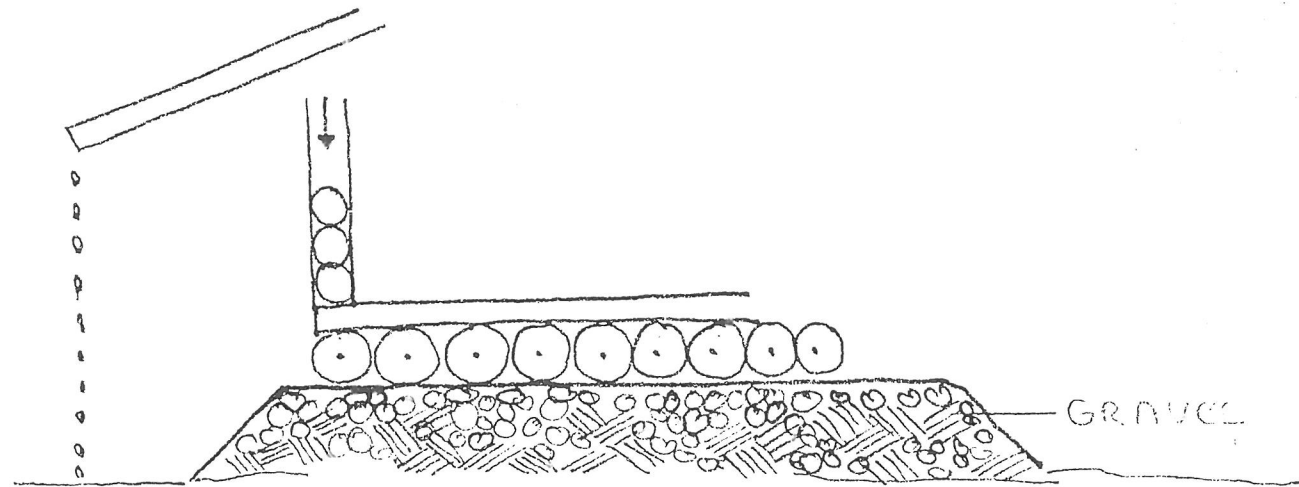

PLYWOOD
LOGS

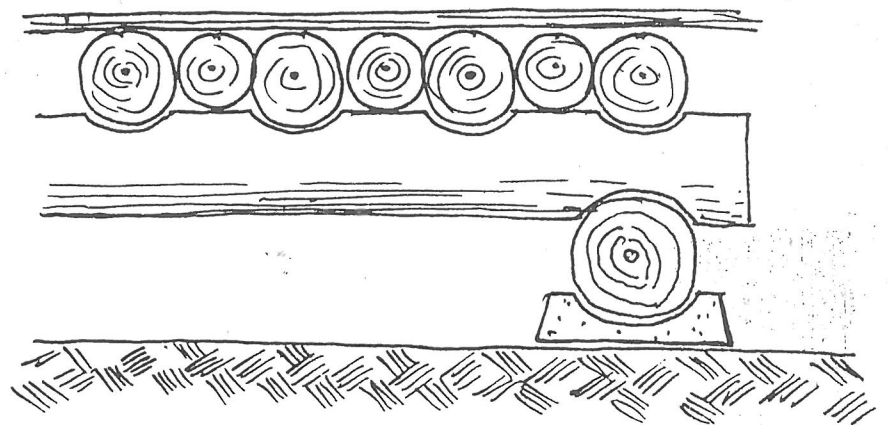

STONE
SOIL

CARPET
PAPER
CESTRICH
LOGS

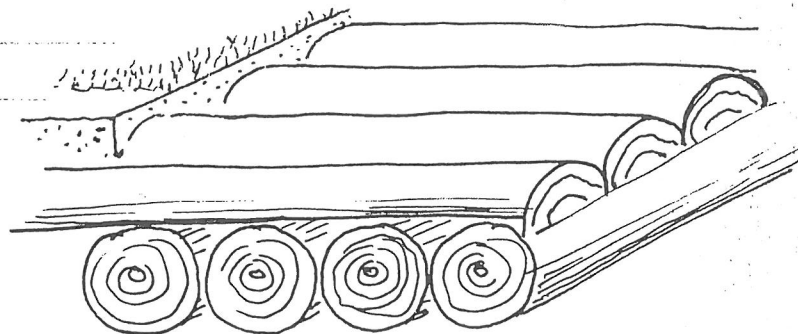

FIBER BOARD
SAND

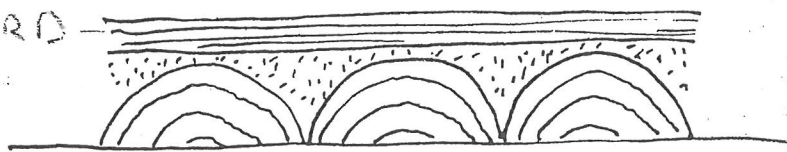

PLYWOOD /
FIBERBOARD OR
PLANKS
TREATED
WOOD
FINE GRAVEL

GRAVEL

SOIL

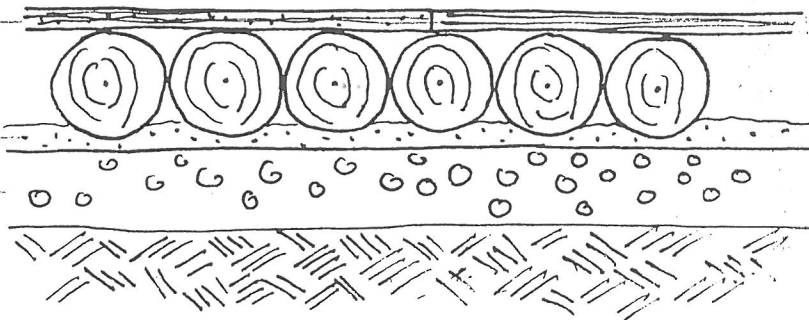

LOGS
FINE GRAVEL
GRAVEL

SOIL

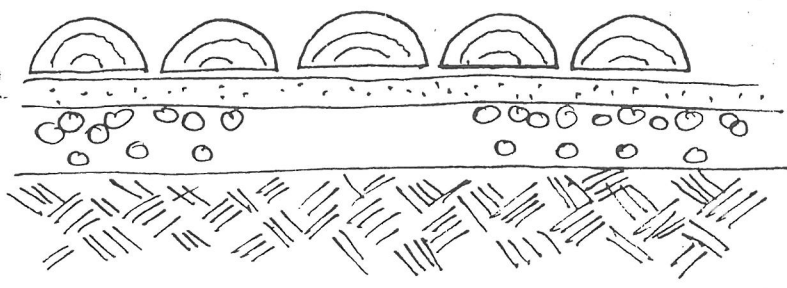

FIBER BOARD OR
PLANKS
SLEEPERS
GRAVEL

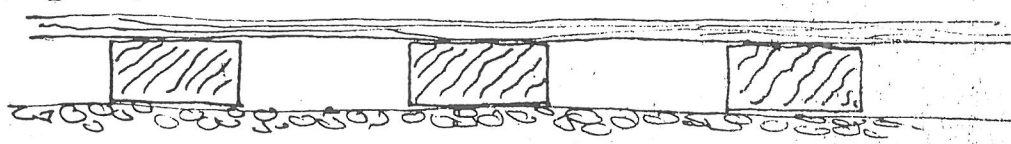

ATELIER FREI OTT WARMBRONN - 7250 LEONBERG 7 BERG ALDE 19 U/152 - 41004 1430007

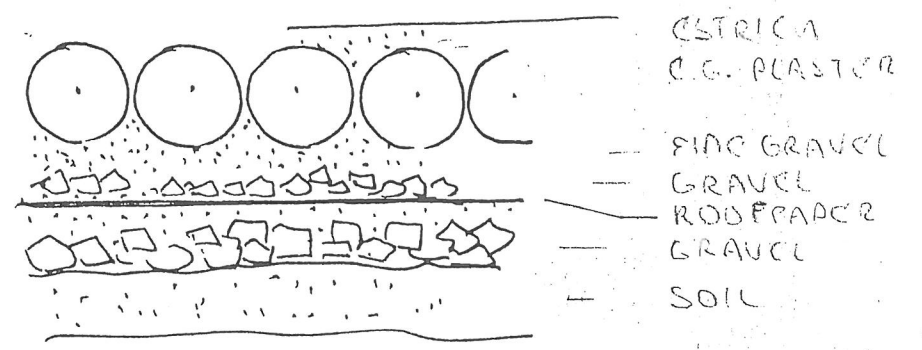
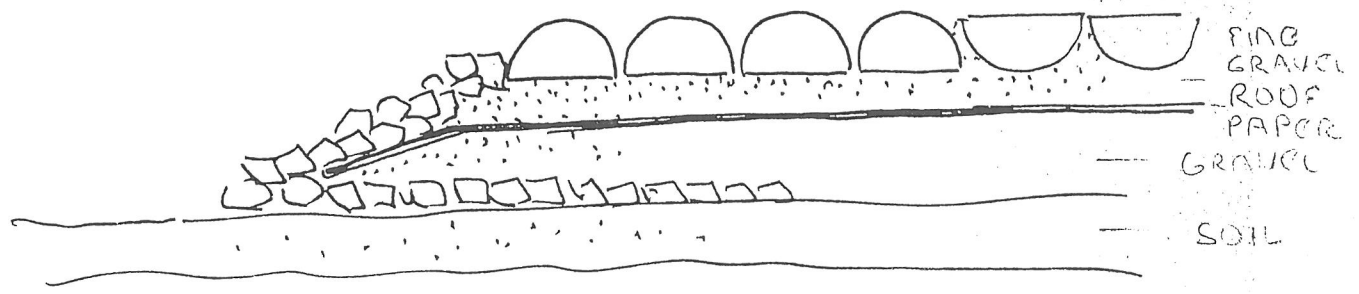

ATELIER FREI OT WARMSTRONN · 7250 LEONBERG 7 BERG ALDE 19 · 07152 · 41064 · 1734683

WALLS

SHRIMPING

MUCH

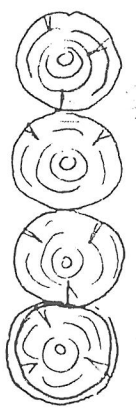

LESS

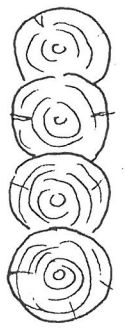

LITTLE

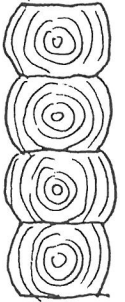

LOG WALLS

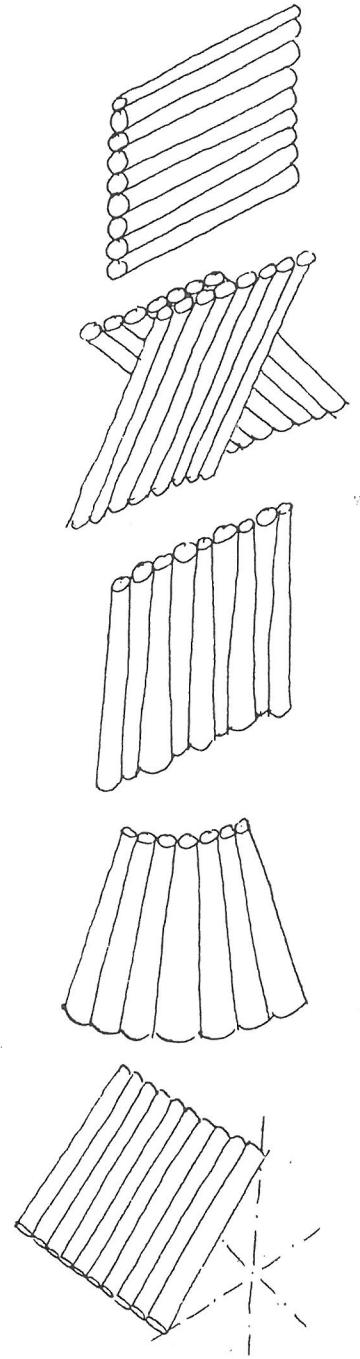

CROSS-LOG-WALL

OPEN OR WITH INFILL

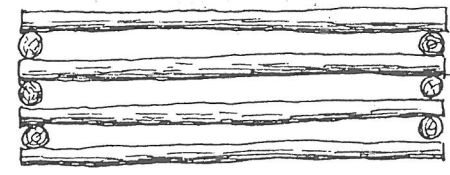

STAGGERED T-JOINTS

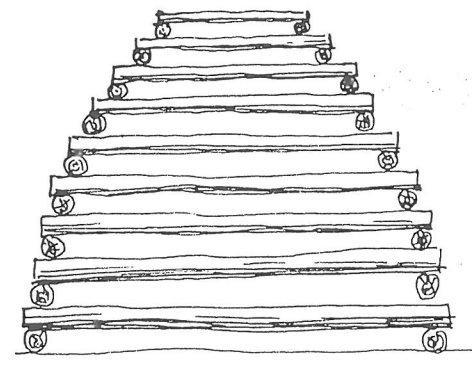
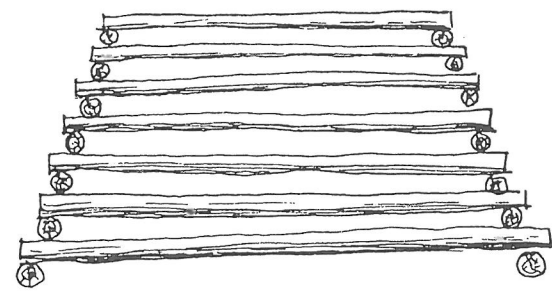
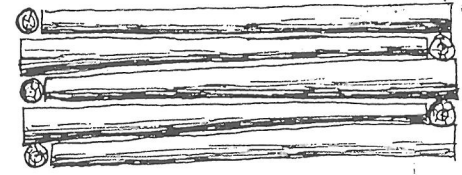

NEEDLE
3/4 CLEAR
PVC TUBE

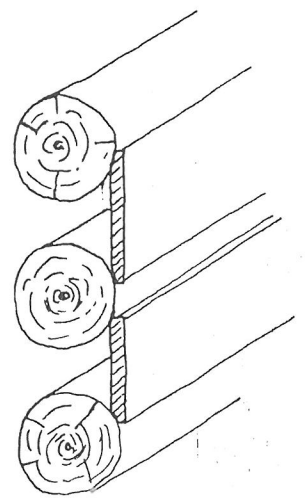
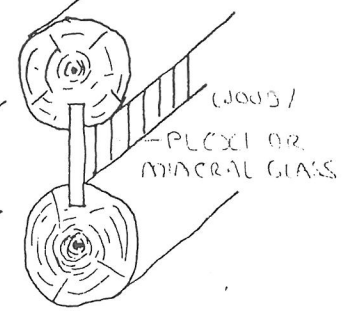
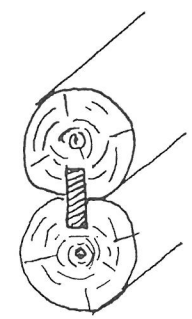
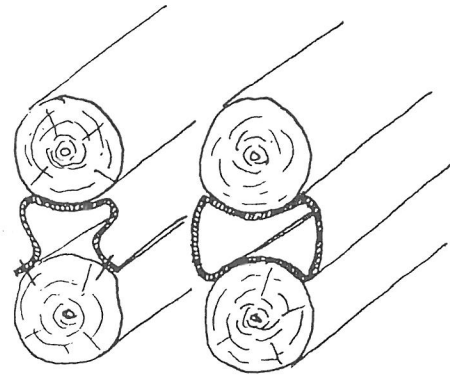

ATELIER FRED OTTO WARMBORN - 7250 LEONBERG 1 - 09122 TROST ARNOLD

WALL OF VERTICAL PILES

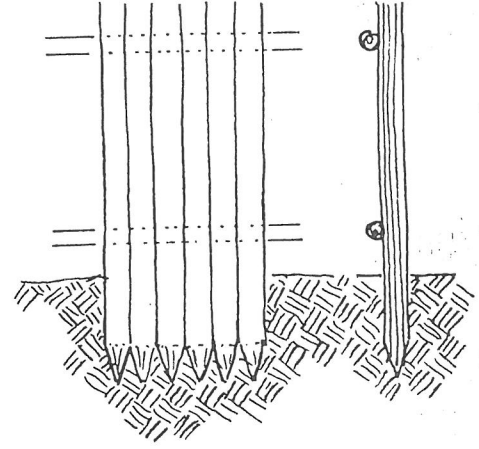
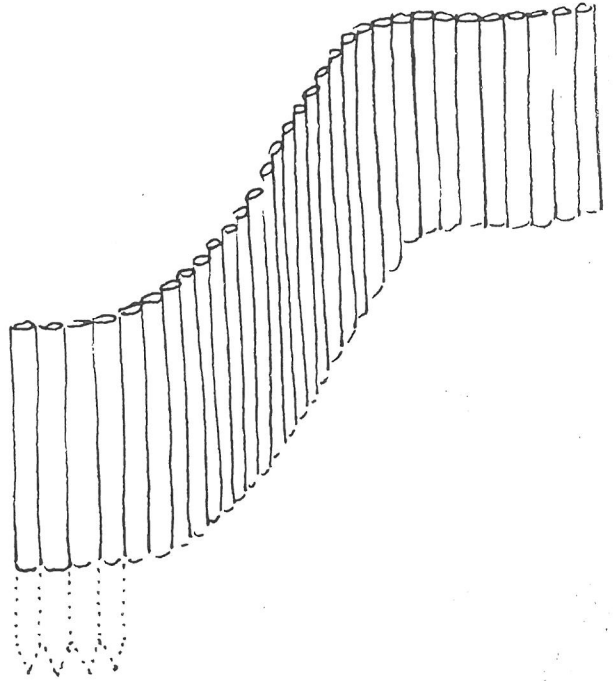

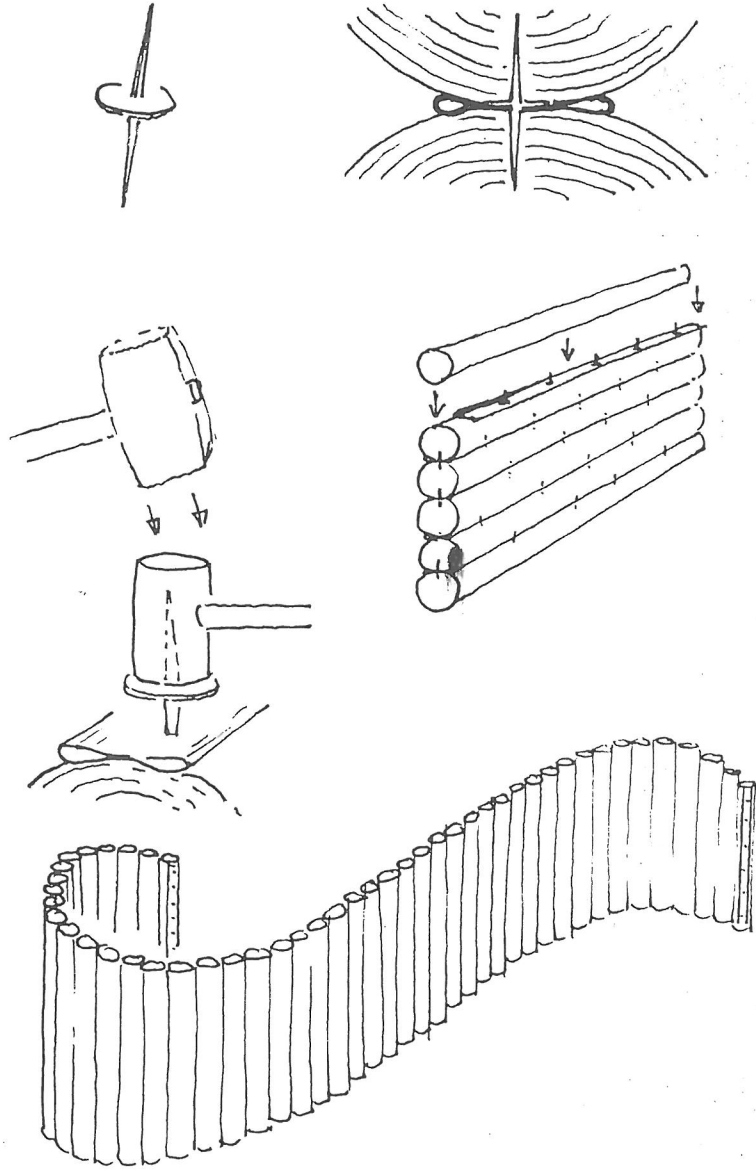

ATELIER FREI OT WARMBRONN - 7250 LEONBERG 7 BERG ALDE 19 07152 - 41084 (43908)

STRING-CONNECTED PILE WALL

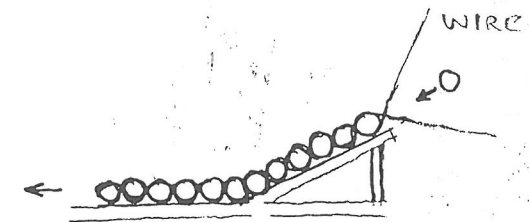
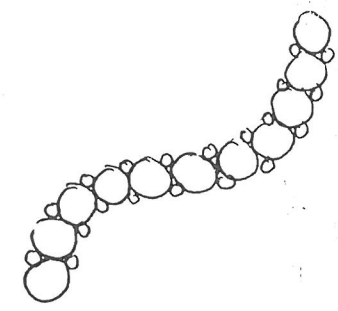
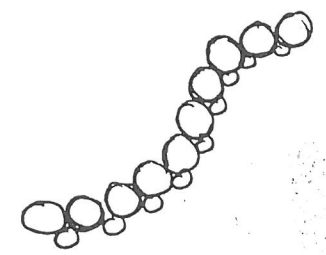
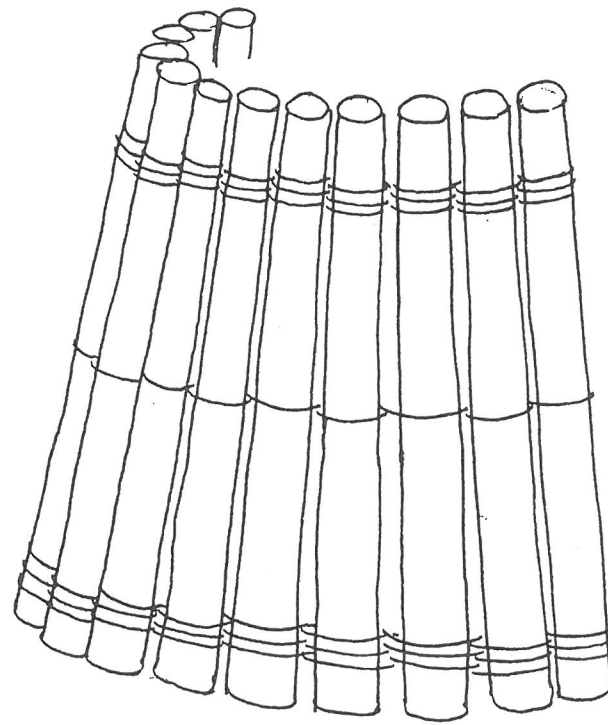

CONNECTION METHOD

NUT + SPRING
WALL

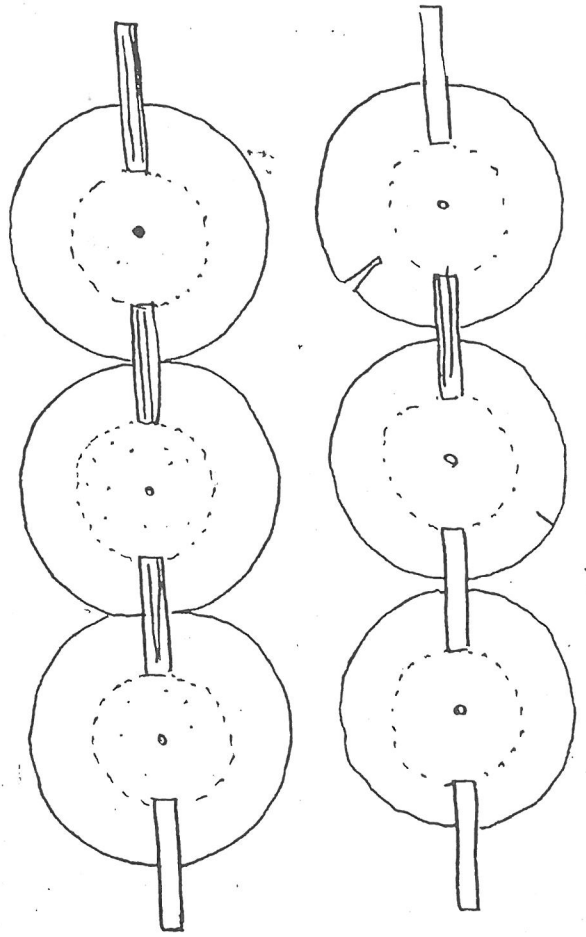
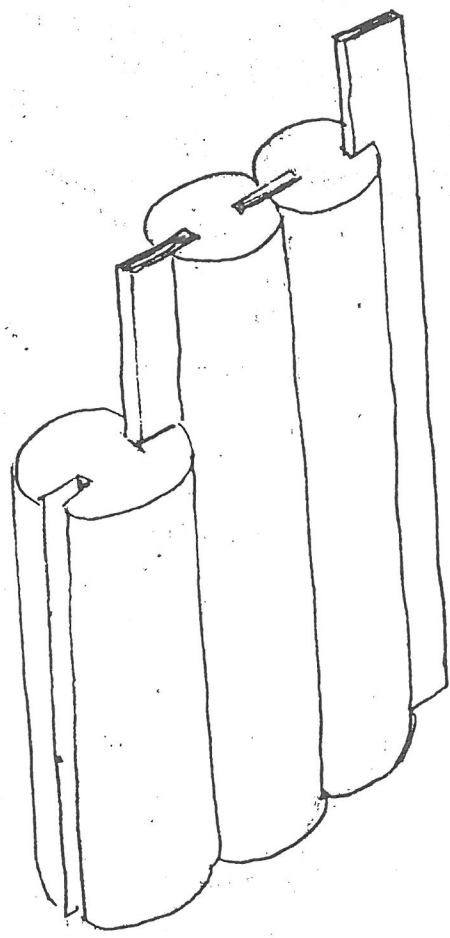

WET

DRY

INSULATED WALL
OF WOODEN BEAMS

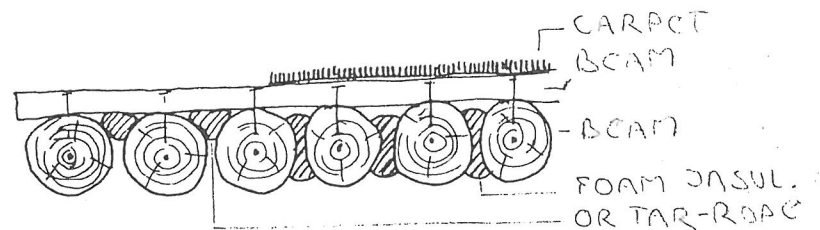
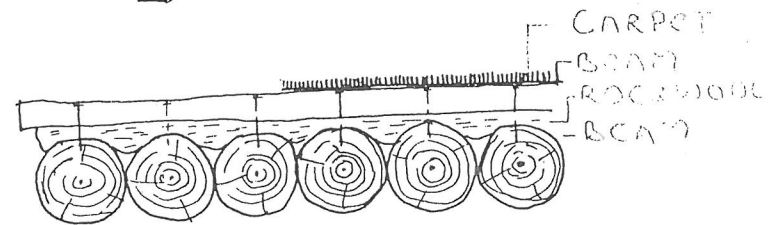
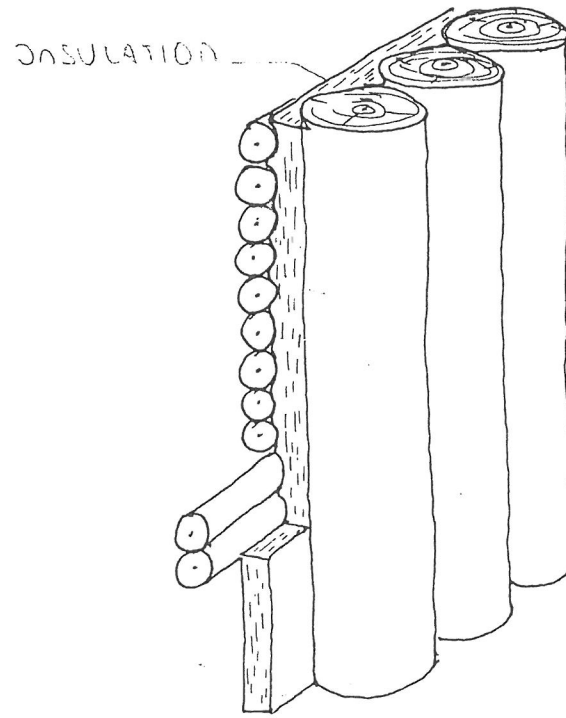

'FIRE WOOD' WALL

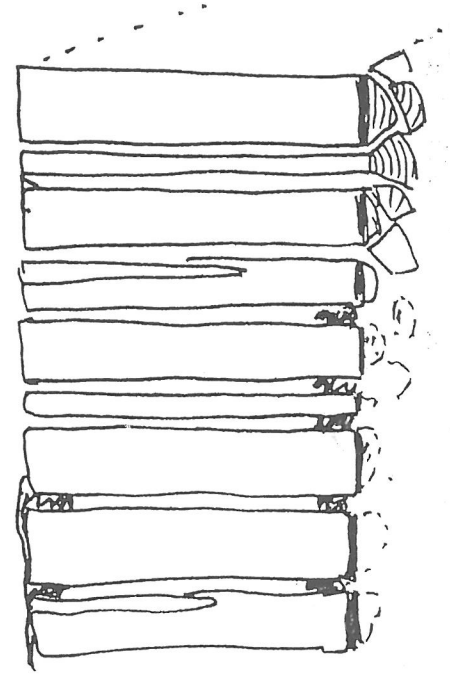
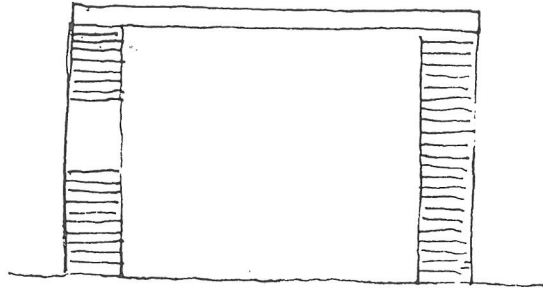

PLANC

PLASTERED
ON ONE SIDE

PLASTERED
ON TWO SIDES

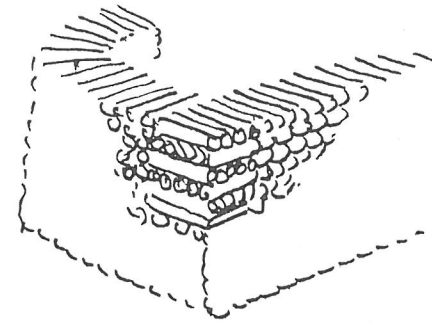

DOUBLE TEXTILE WALL

TRANSPARENT OR
TRANSLUCENT FOIL
OR CANVAS

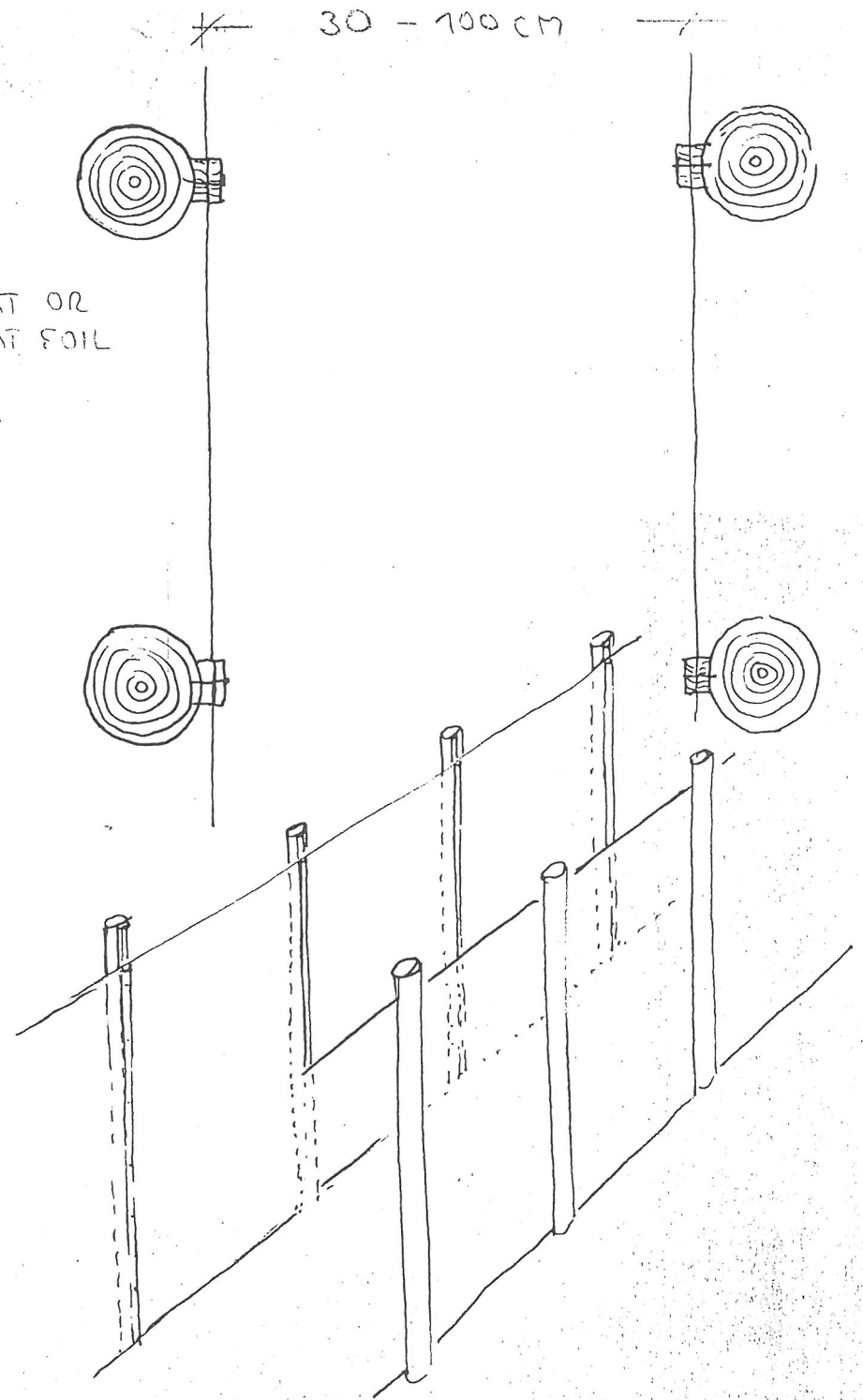

ATELIER FREI OT WARMBRONN - 7250 LEONBERG 7 BERG - DE 19 07152 - 41084 (43908)

ATELIER FREI OT WARMBRONN - 7250 LEONBERG 7 BERG - DE 19

ATELIER FREI OT WARMBRONN - 7250 LEONBERG 7

ATELIER FREI OT WARMBRONN - 7250 LEONBERG 7

ATELIER FREI OT WARMBRONN - 7250 LEONBERG 7

ROOFING

ROOFS

WEATHER SKIN -
CLIMATE HULL

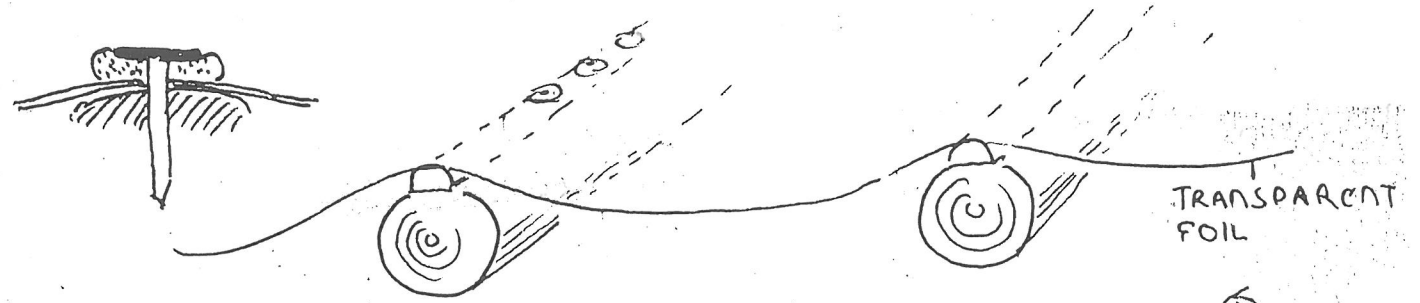

INSULATED ROOF

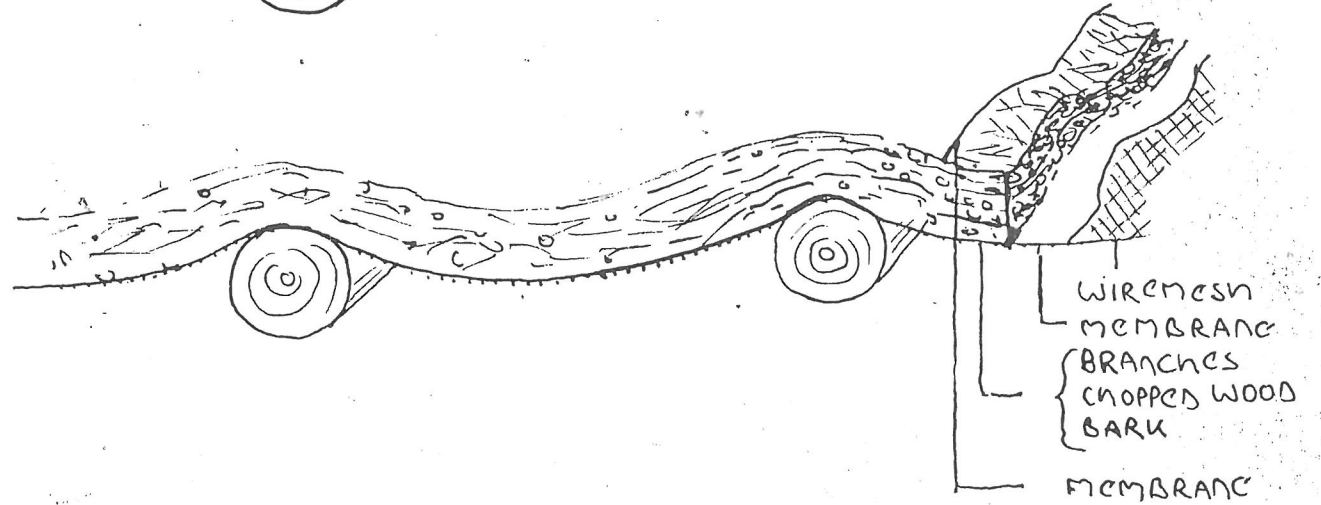

MOSS / GRASS ROOF

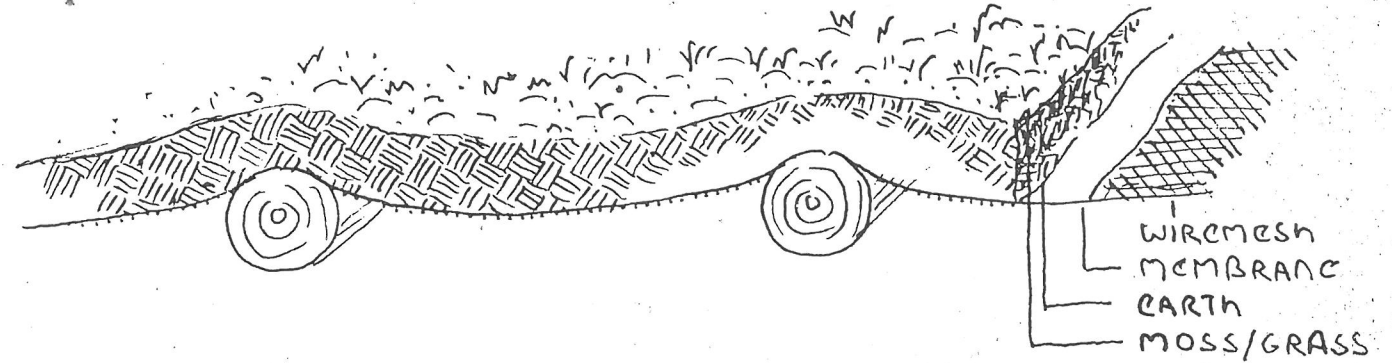

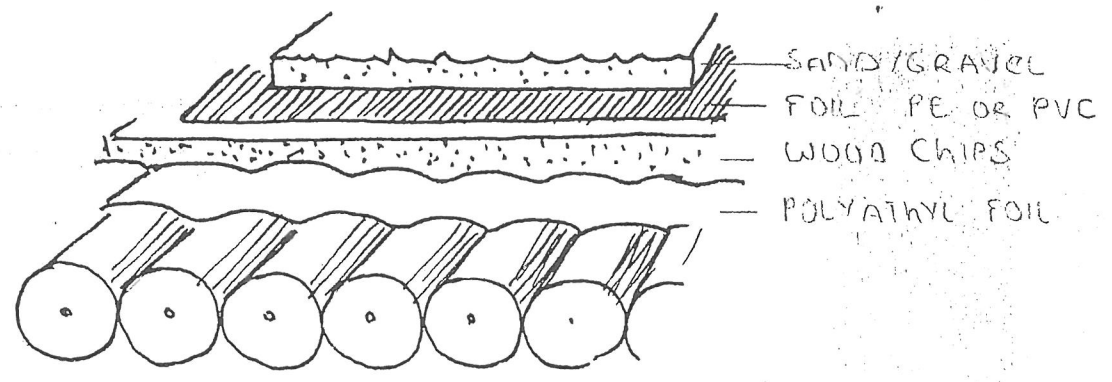

TOUGHENED ACRYL GLASS
NON BURNING

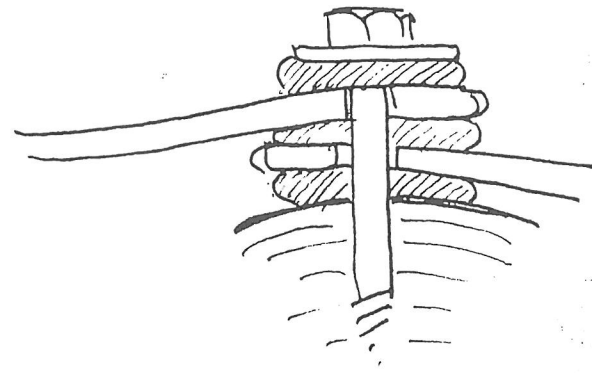
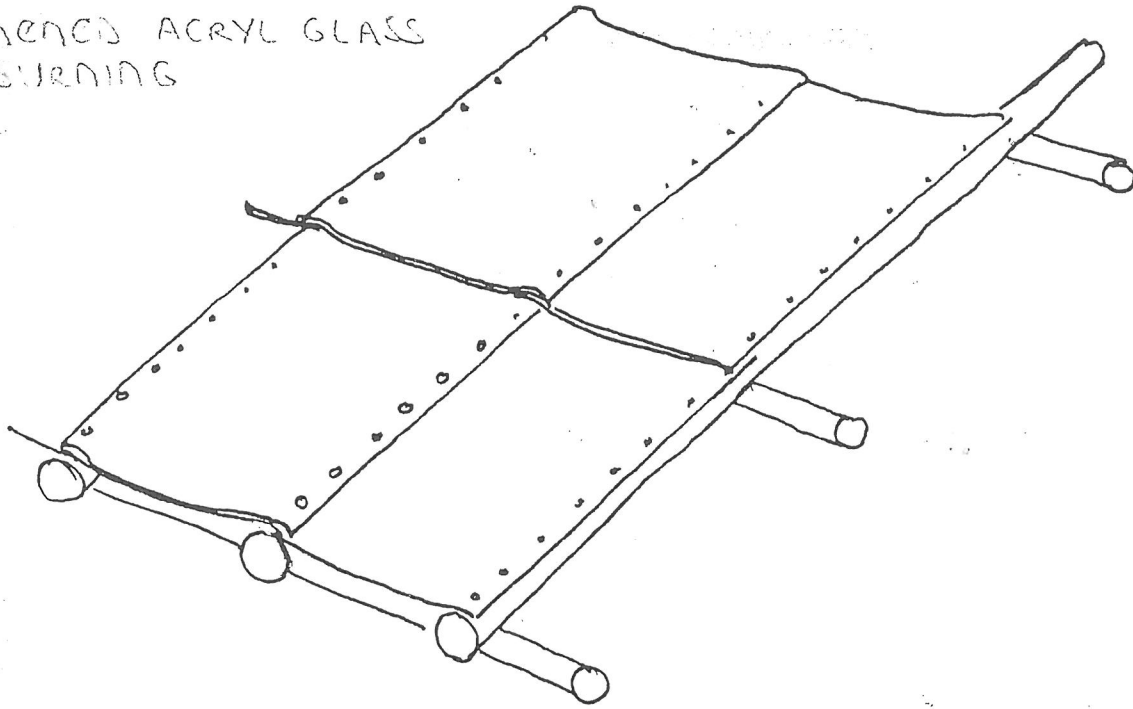

ATELIER FREI OT WARMBRONN - 7250 LEONBERG 7 BER ALDE 19 ☎ 07152 - 41084 (439008

SCCLETON AND FRAMEWORK

CROSS CONNECTIONS

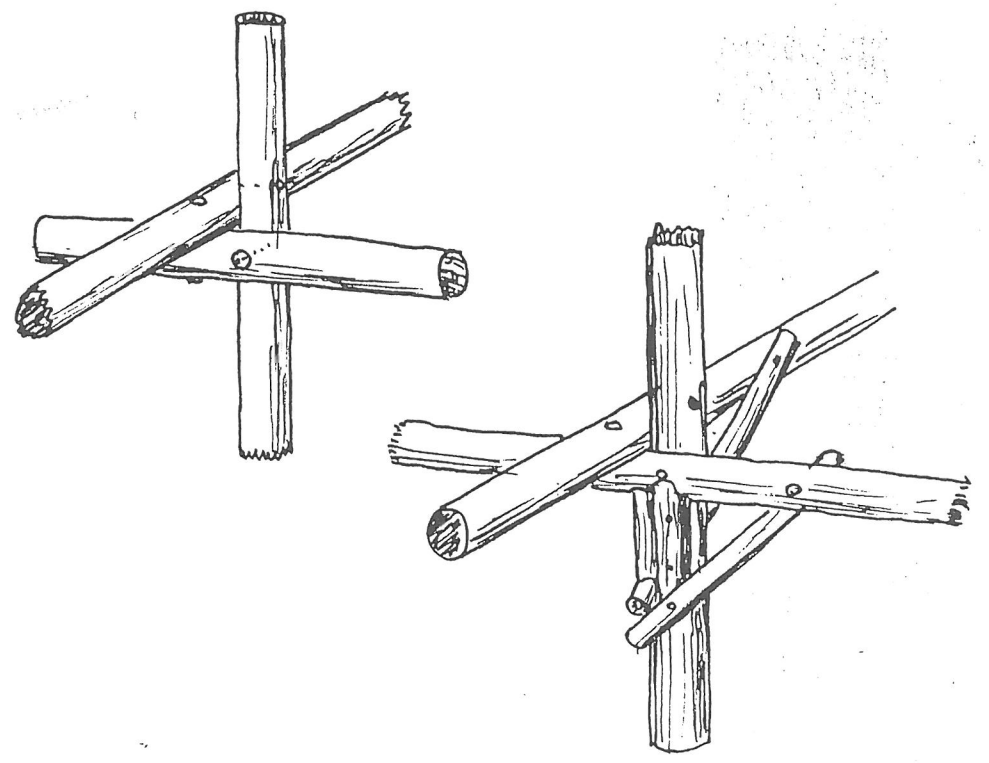

ATELIER FRED OT - WARMBRONN - 7250 LEONBERG 7 BERG - LDC 19 © 07152 - 41064 (430001)

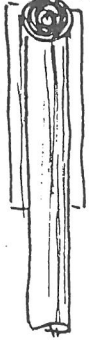
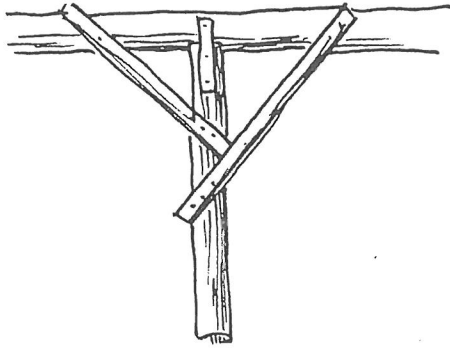
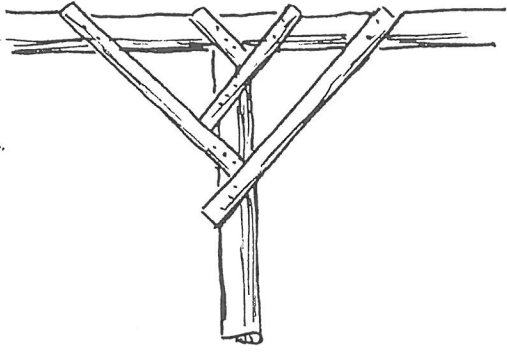

7250 LEONBERG 7 BE HALDE 19 07152 - 41084 (430)

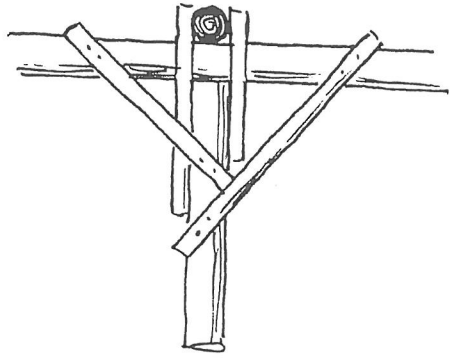
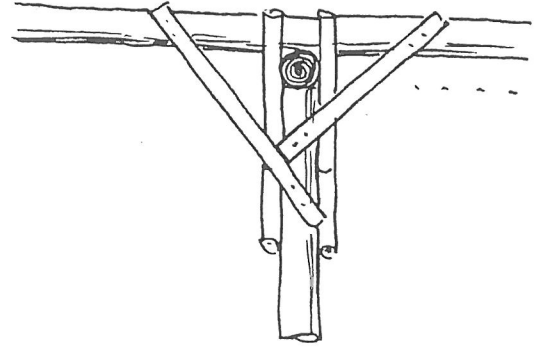

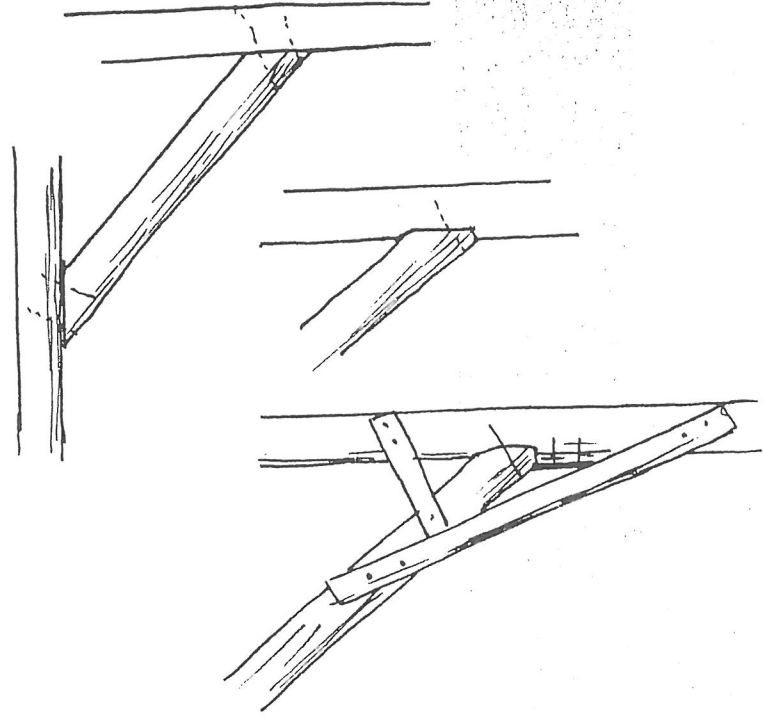
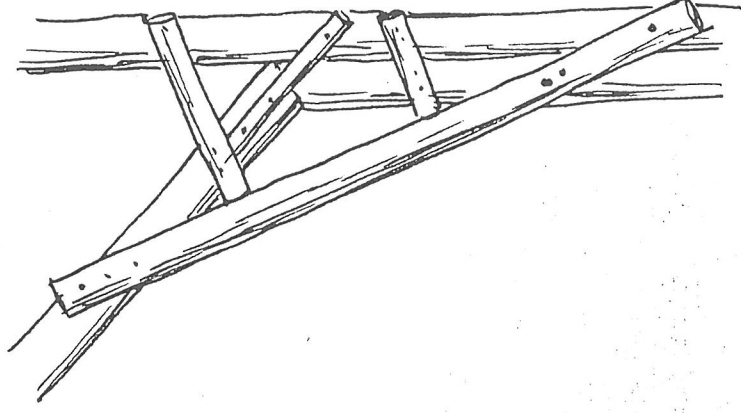
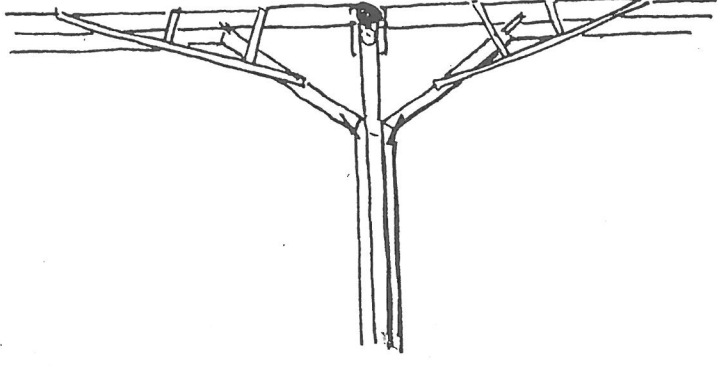

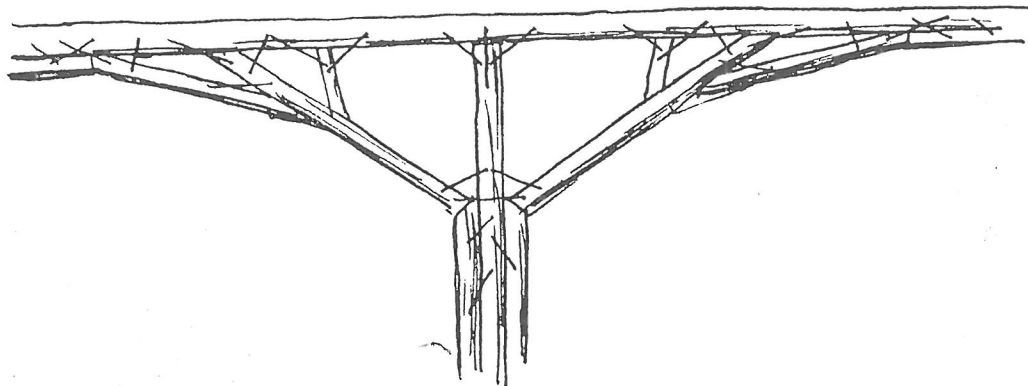
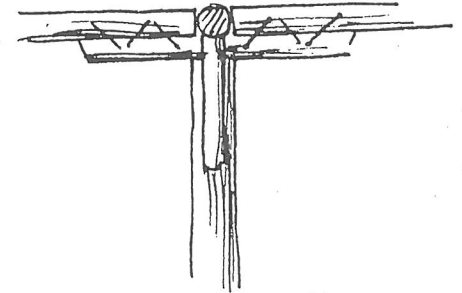
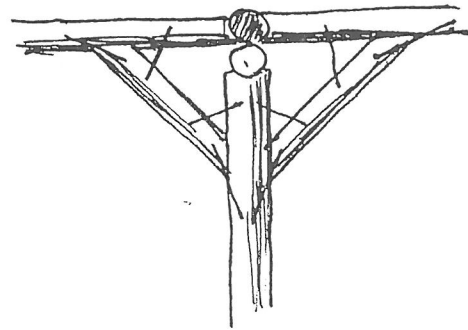
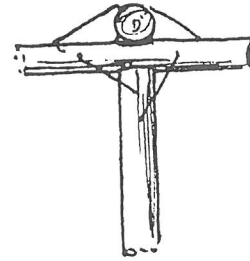
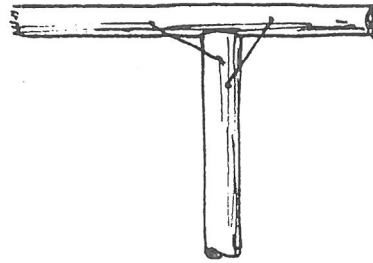
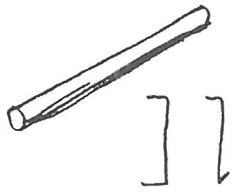

WORKSHOP - HALL
MADE OF WHOLE
TREE - TRUNKS

front length

MOSS / GRASS

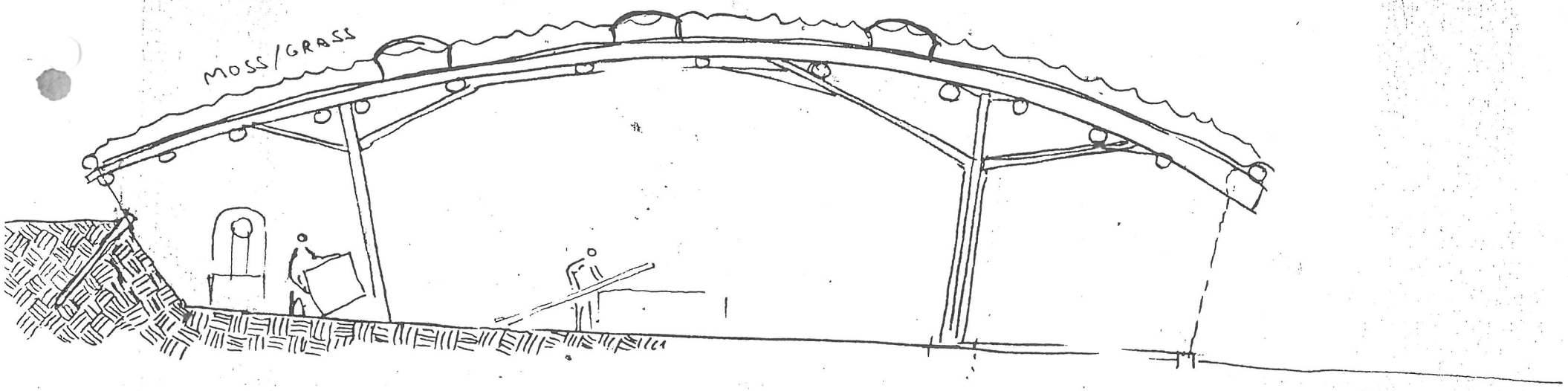

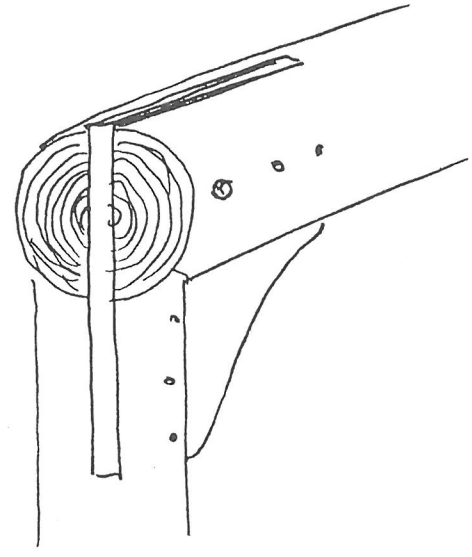
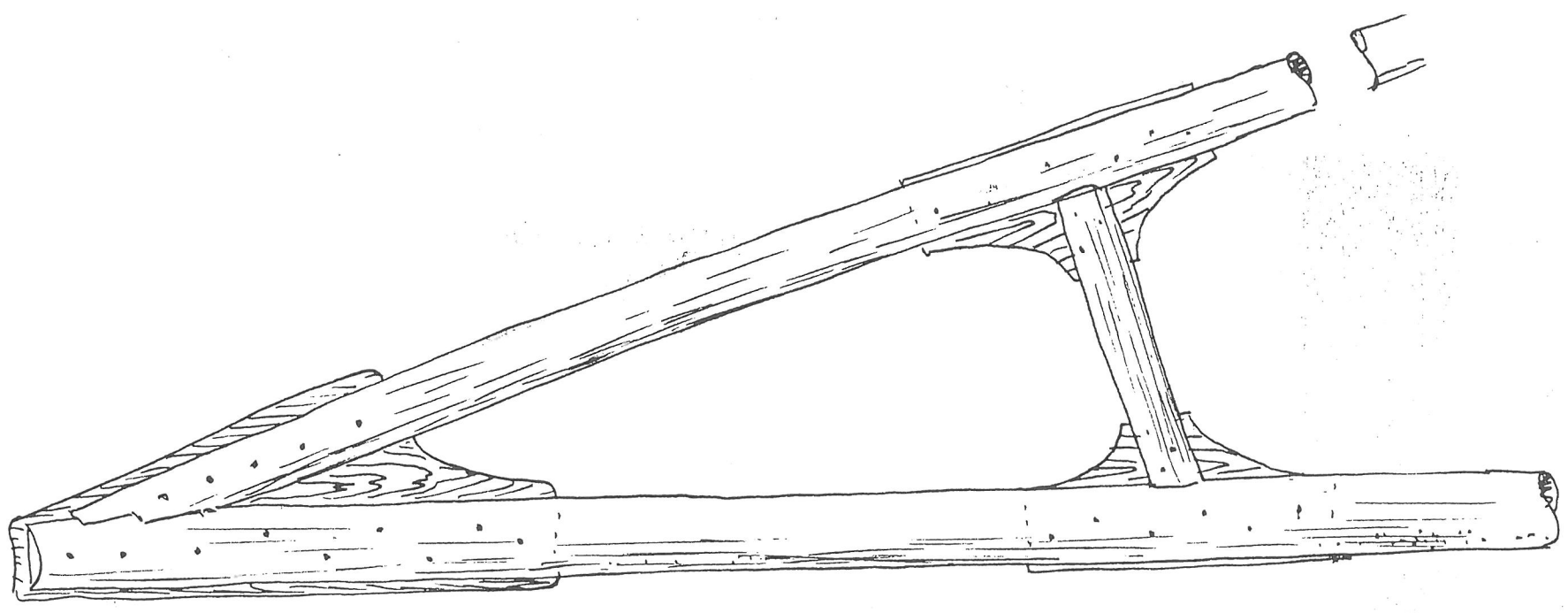

ATELIER FREI OTTO WARMBRONA - 7250 LEONBERG 7 BERG-ALDE 19 07152 - 41004 (439000)

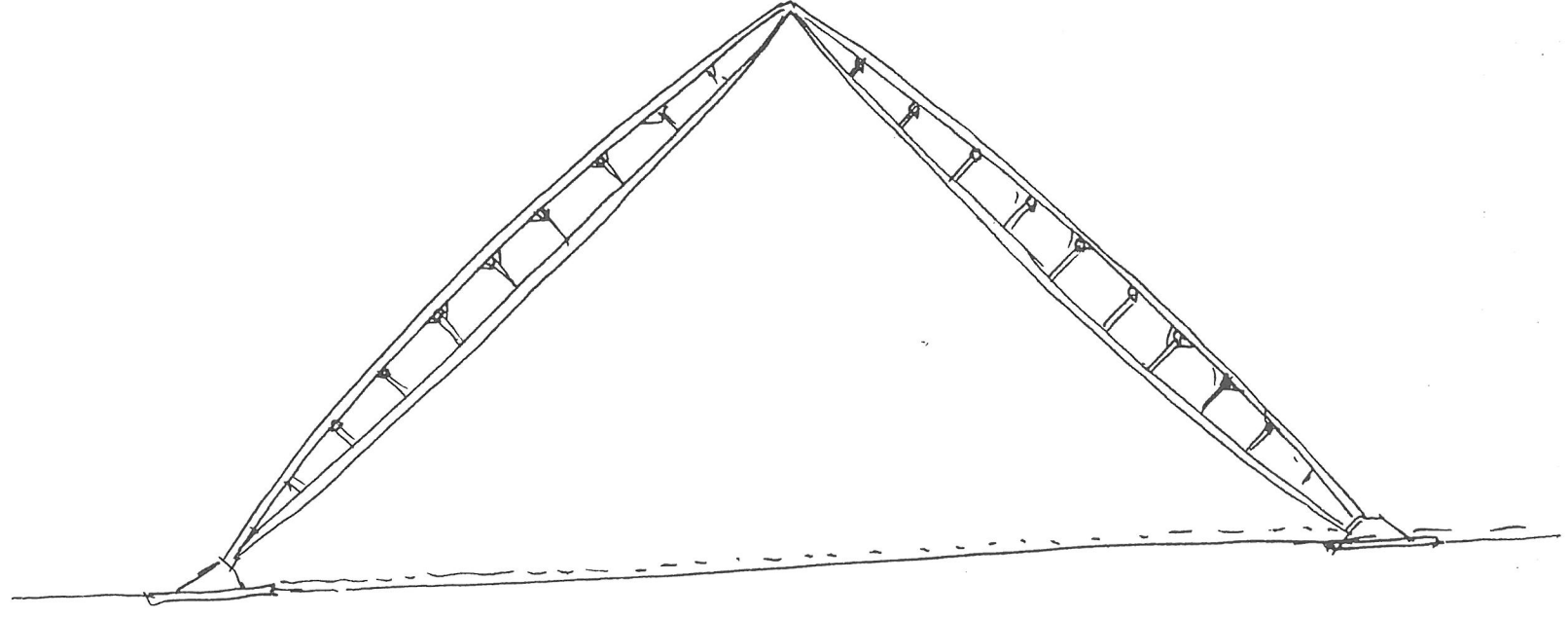

ATELIER FREI OTT WARMBRONN 7250 LEONBERG 7 BEHG 1 DE 19 € 0152 - 41004 (0,35€)

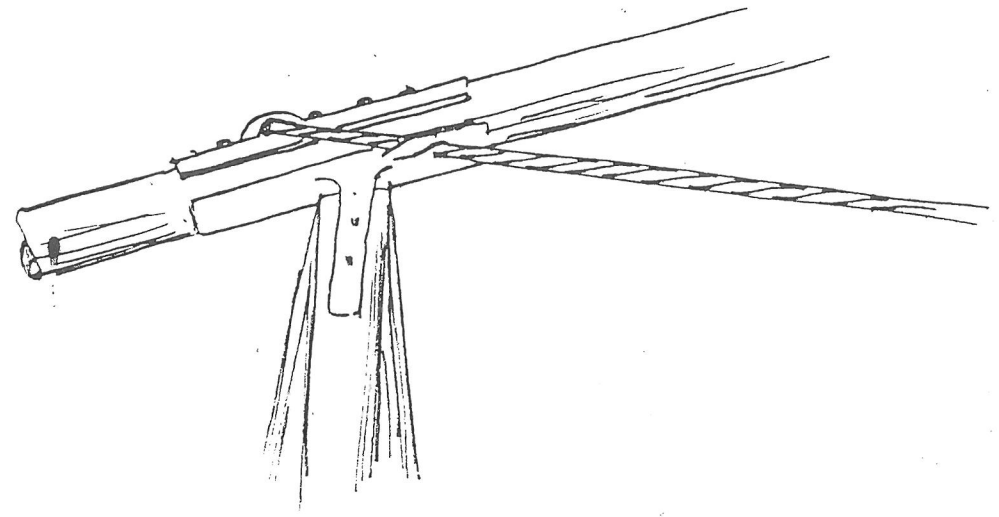
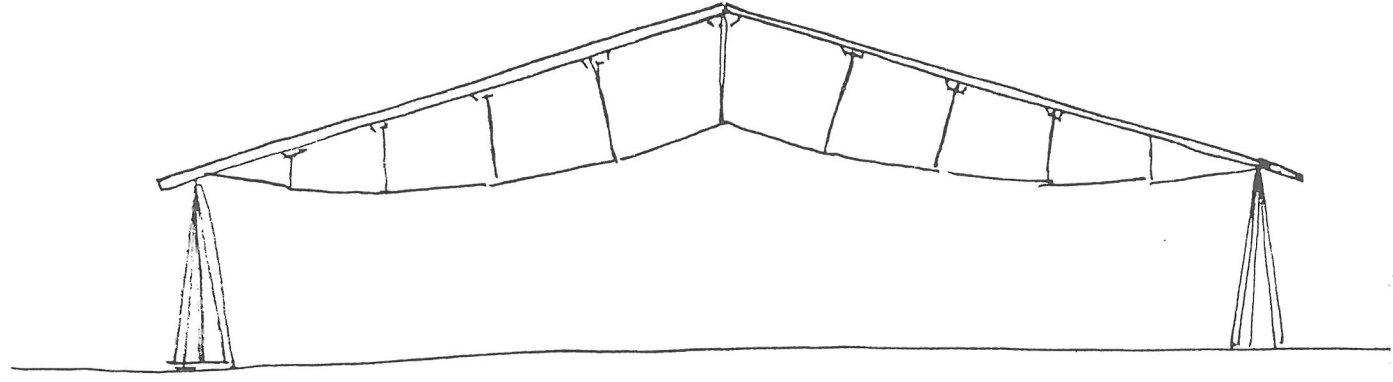

ATELIER FREI OT WARMBRONN - 7250 LEONBERG 7 BERG LDC 19 07152 - 41084 (43908)

SNELLS

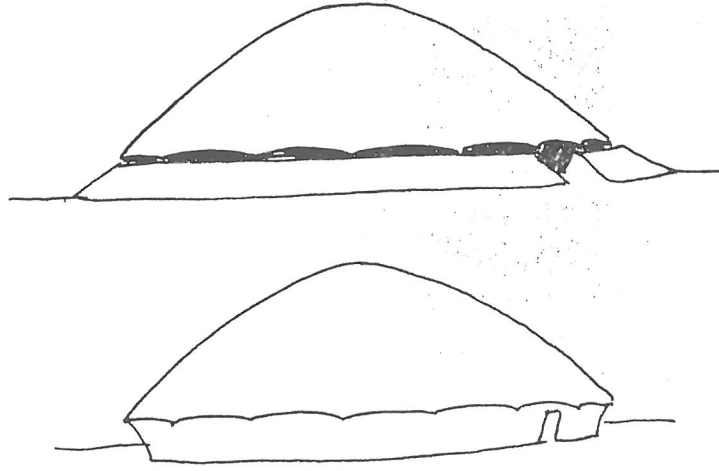
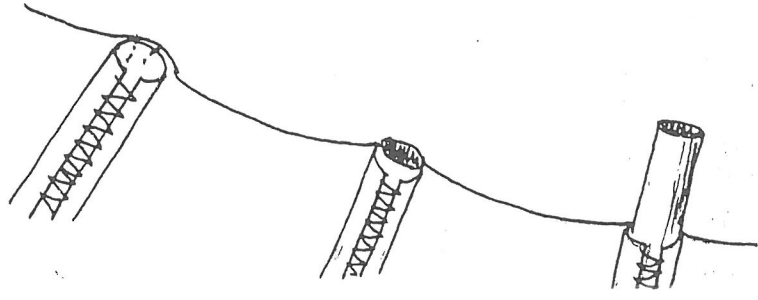
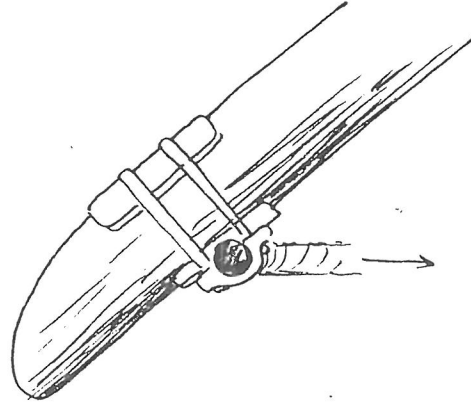
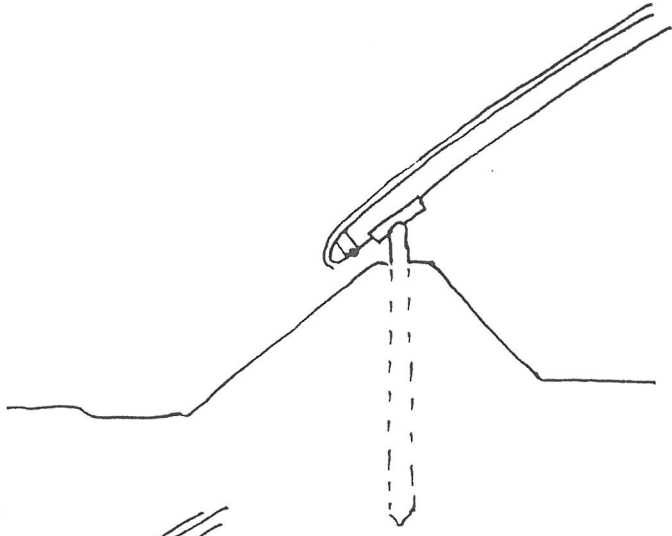
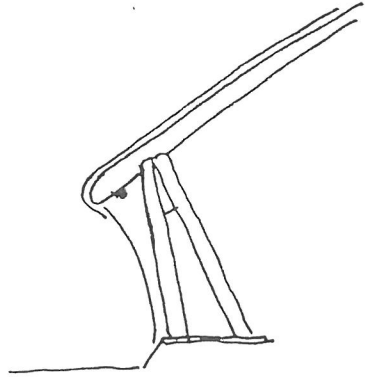

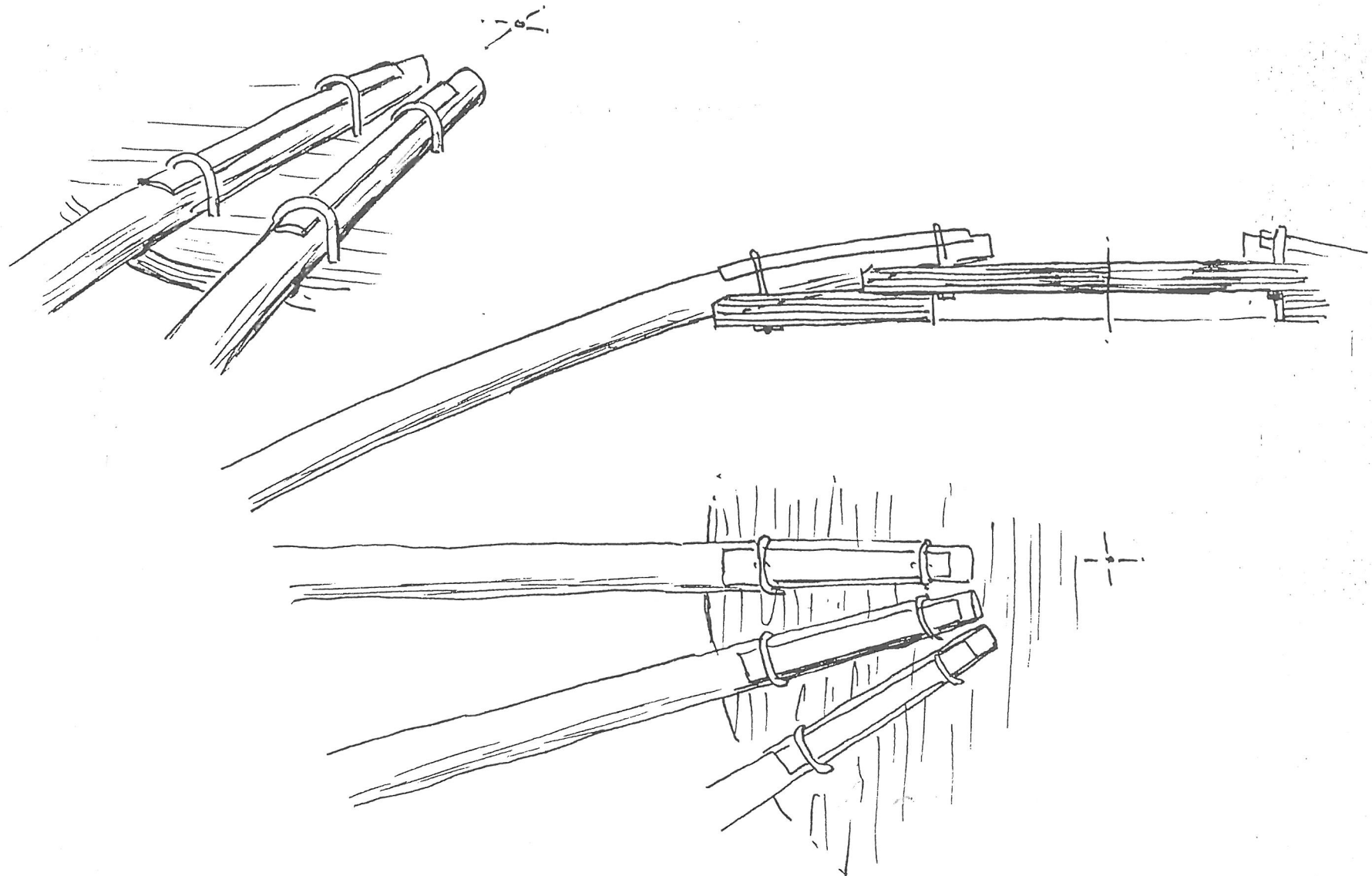

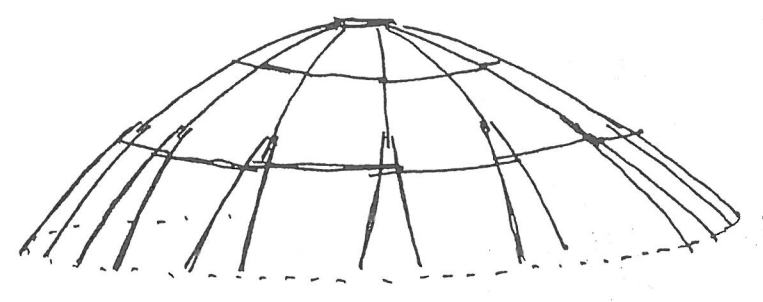
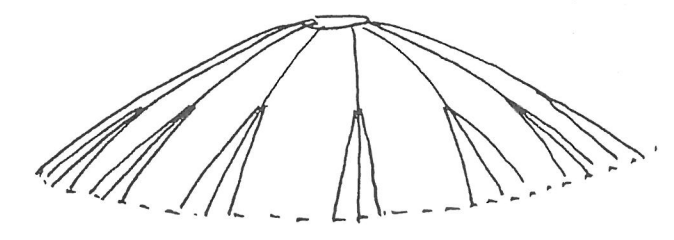
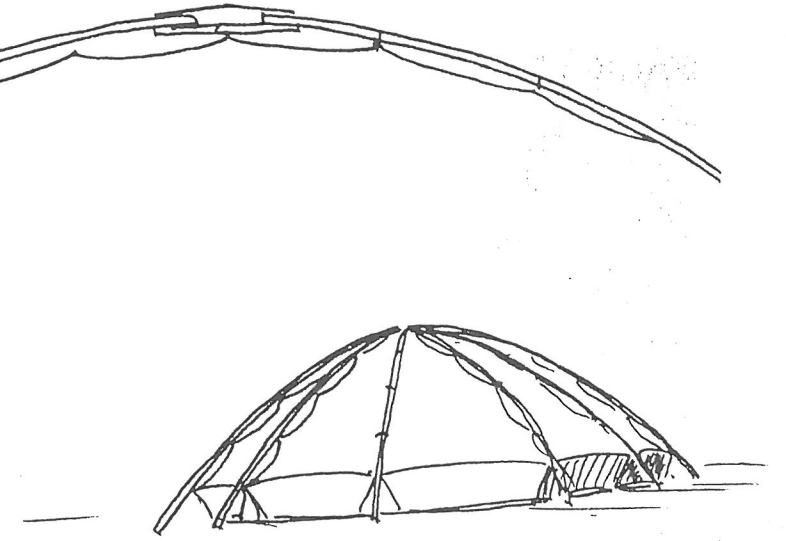
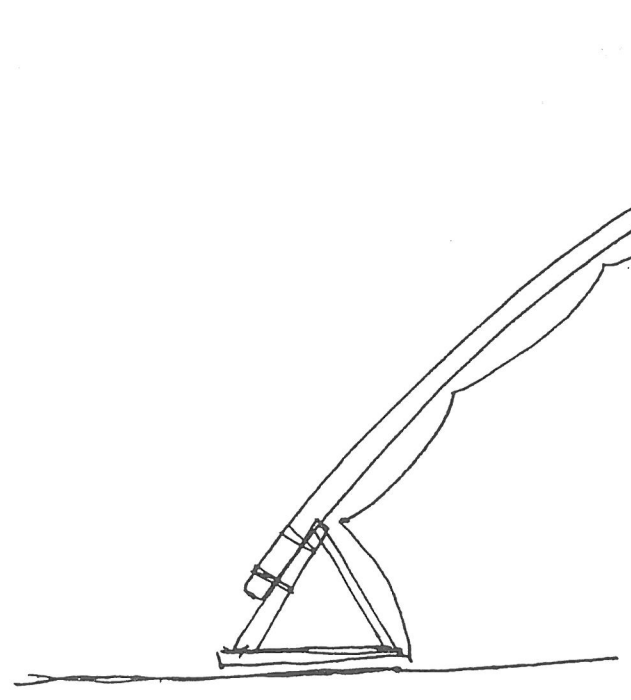

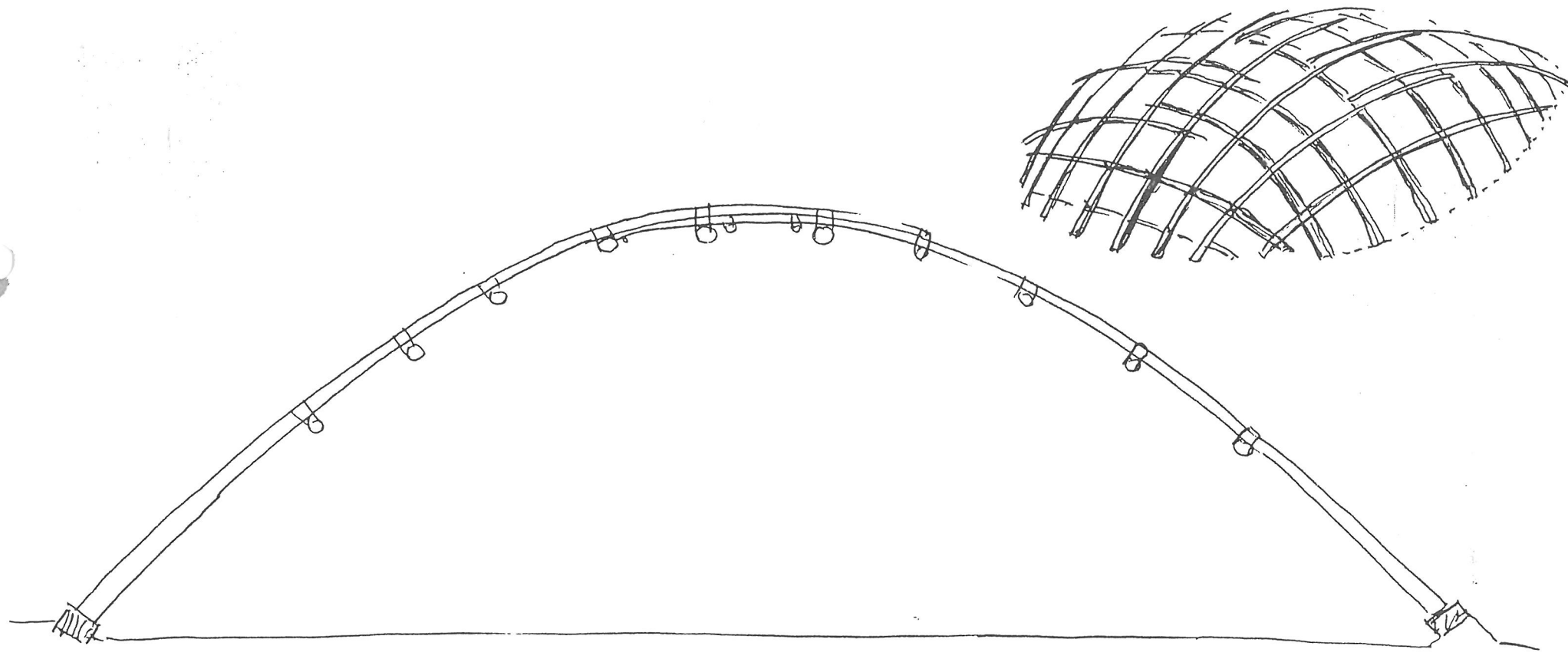

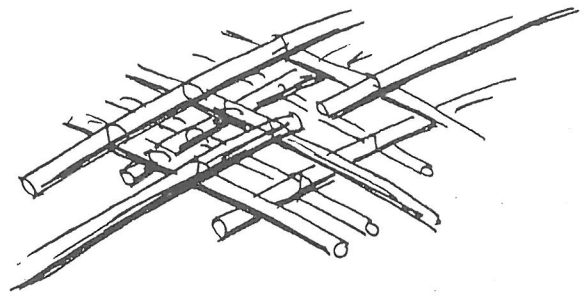
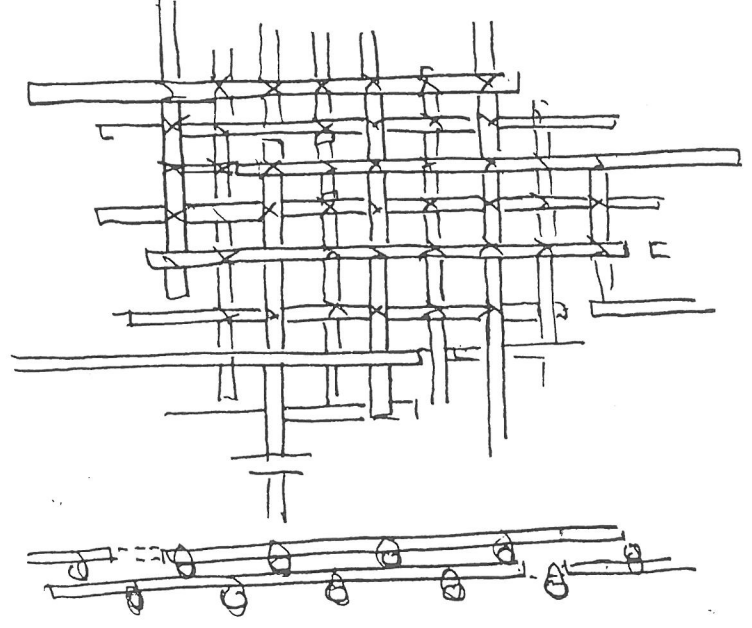
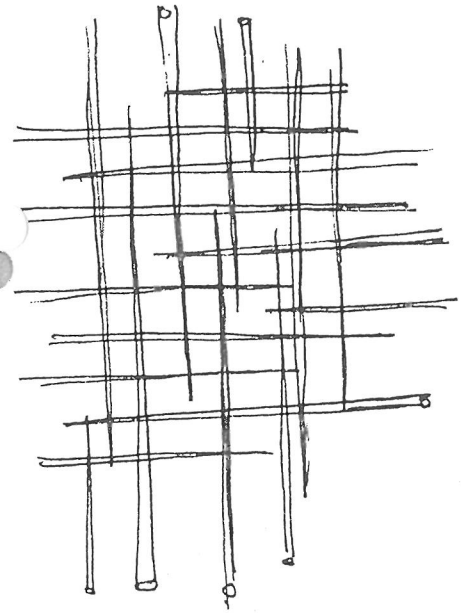

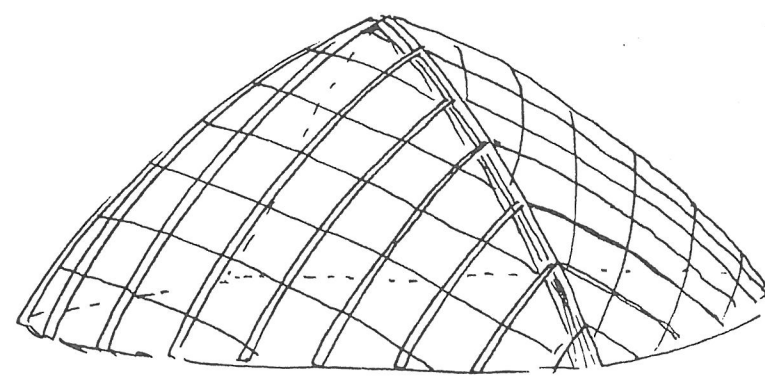
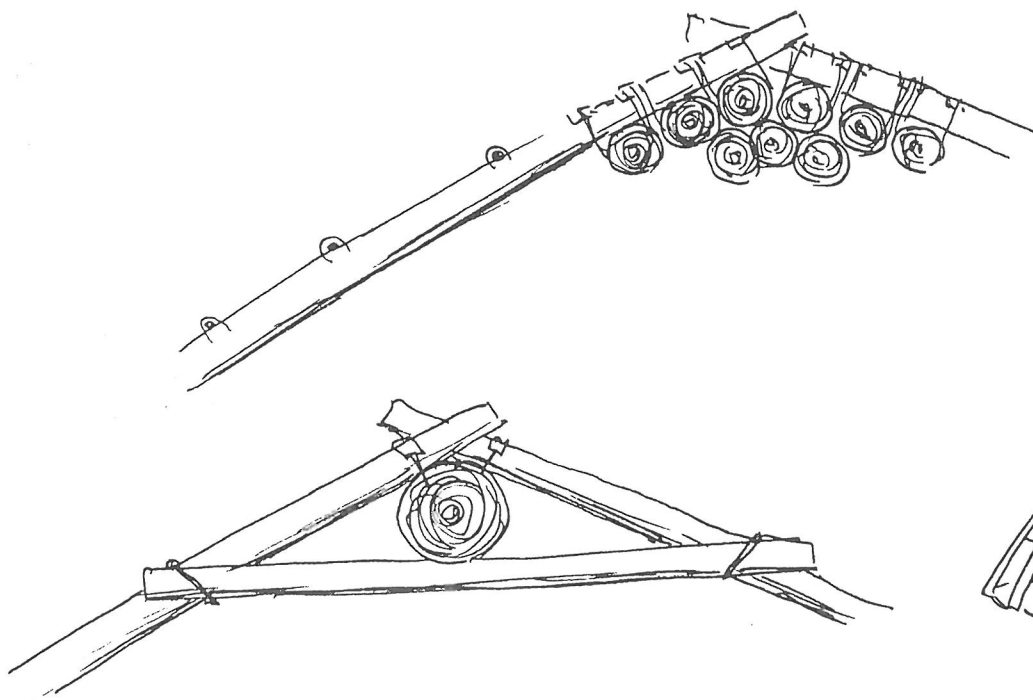

ATELIER FREI OT WARMBRONN - 7250 LEONBERG 7 BERG ALDE 19 07152 - 41084 (43901

TENTS

ATELIER FREI OT WARMBRONN - 7250 LEONBERG 7 BERG ALDE 19 07152 - 41084 (43908)

EARTH TREAT

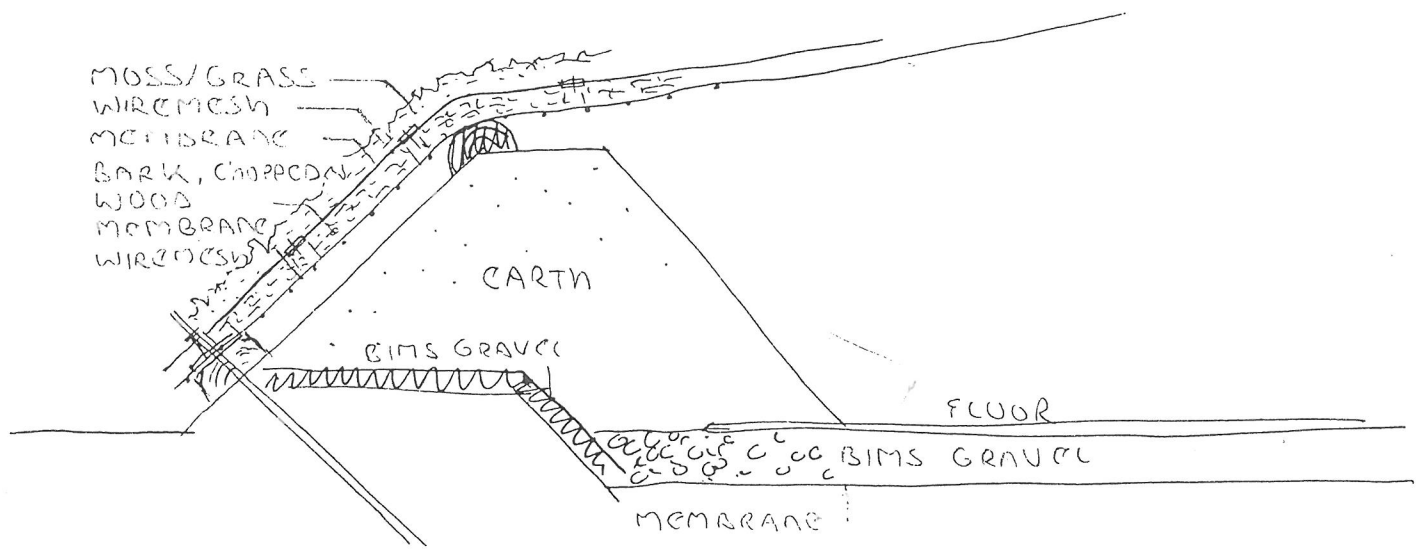
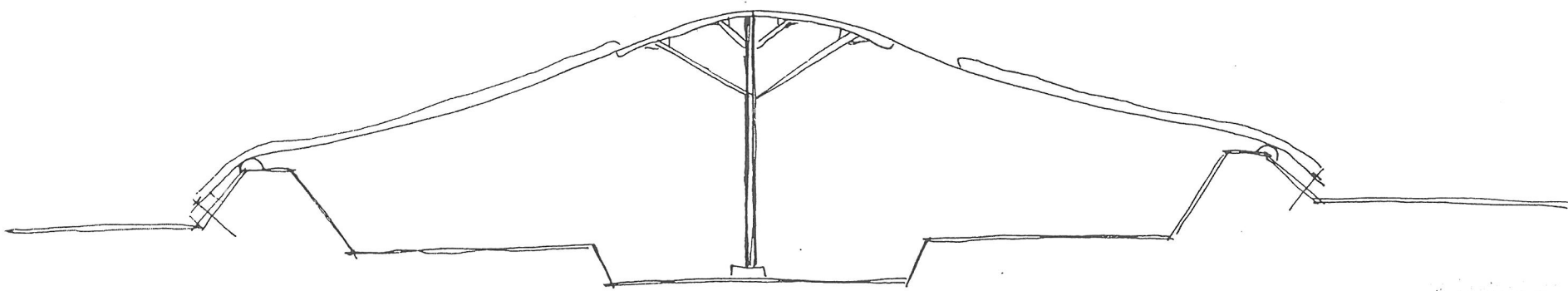

CANTH TENT

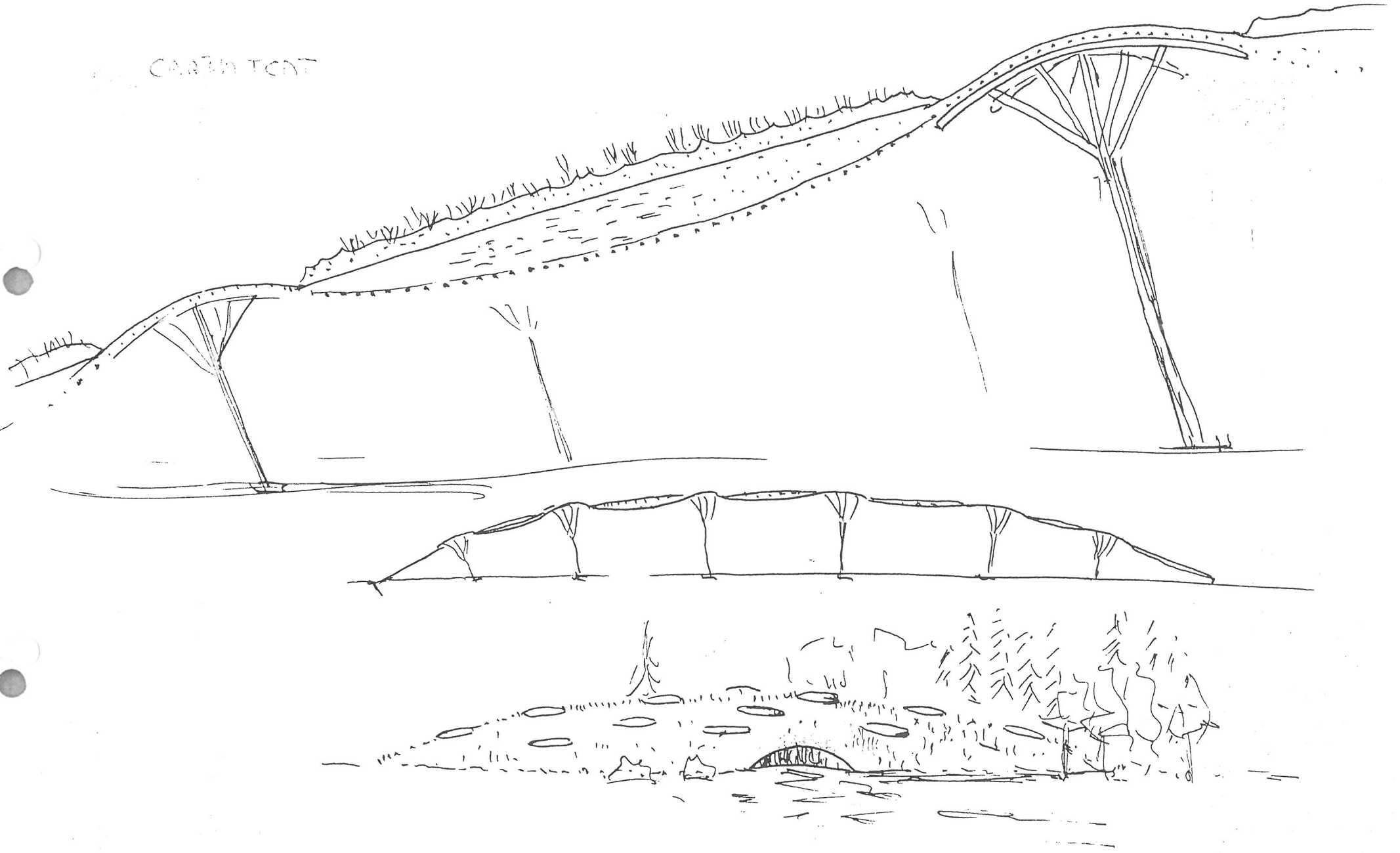

CANVAS + WOOD TENT

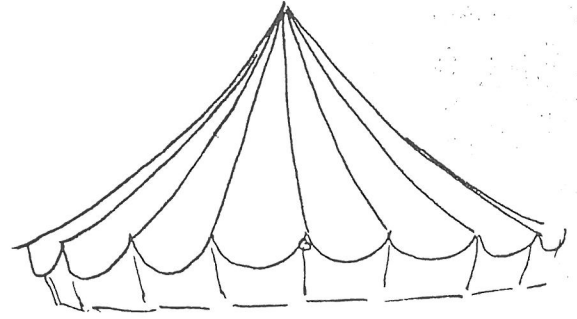
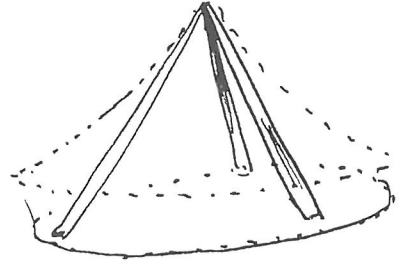

BLOODEH CANVAS

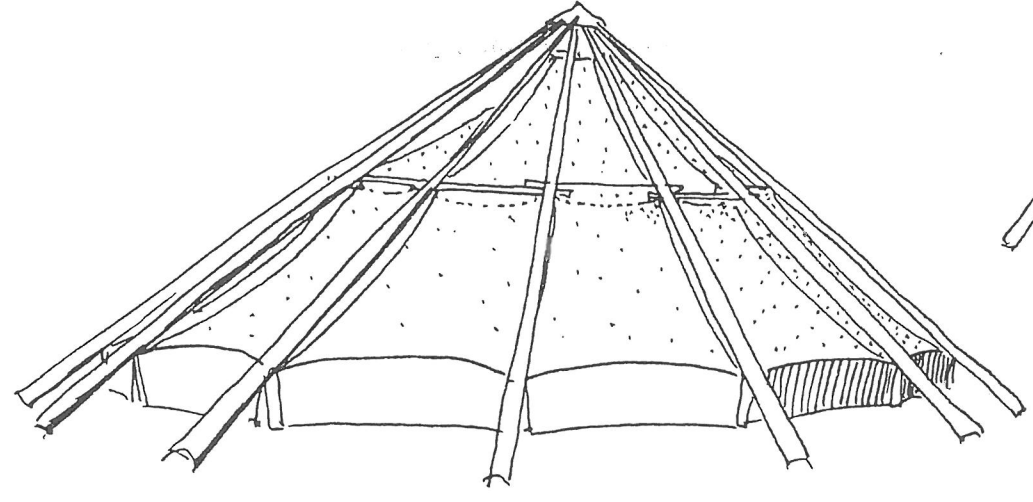

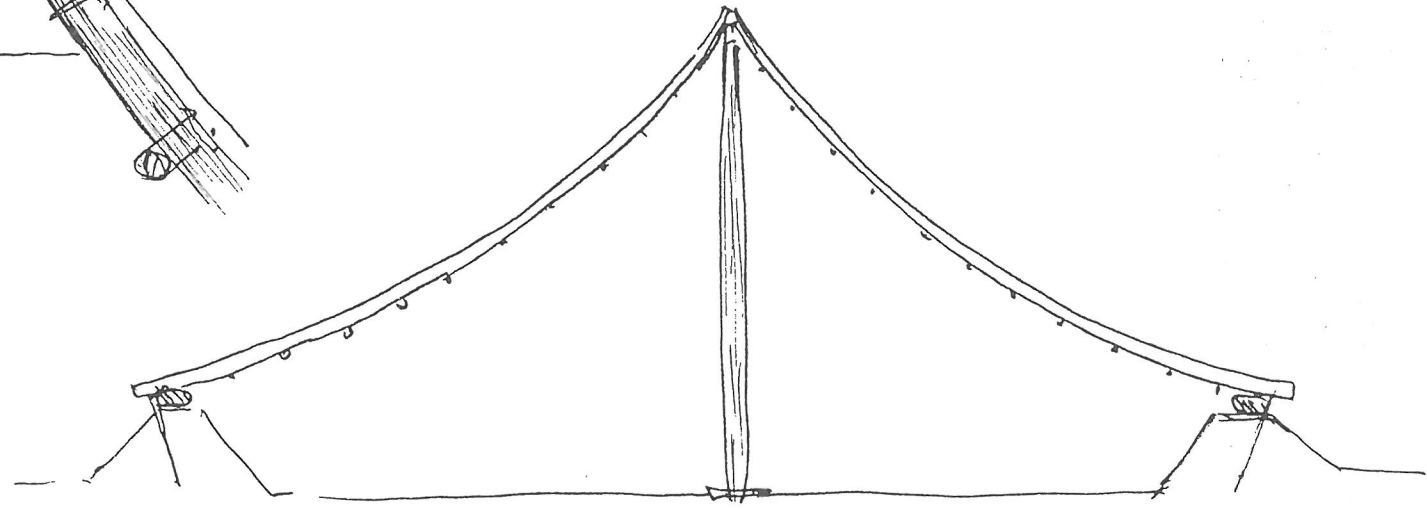
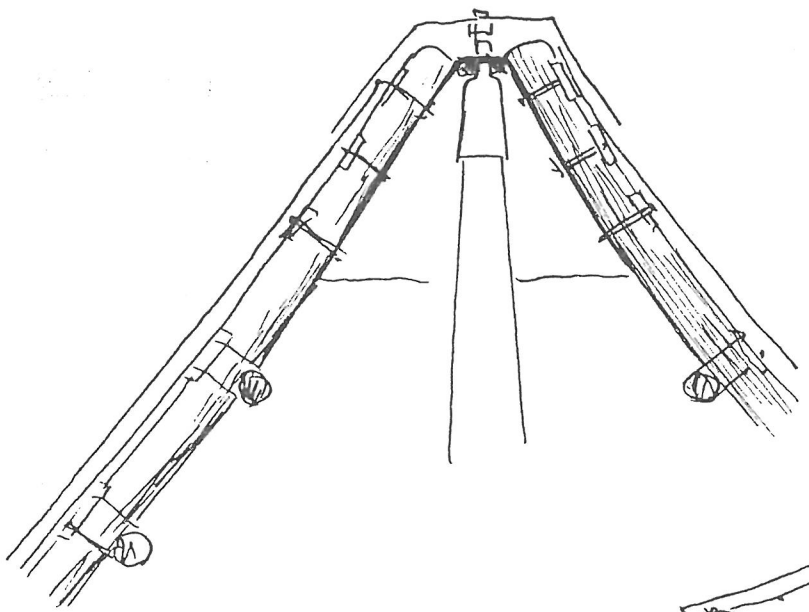

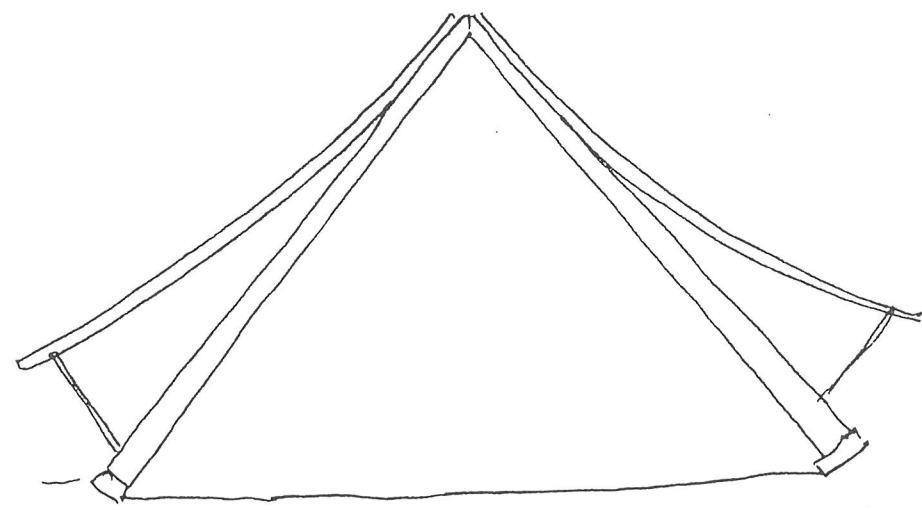
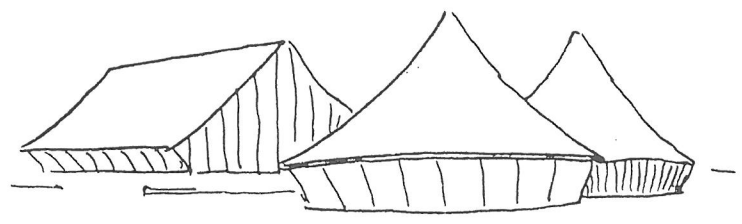
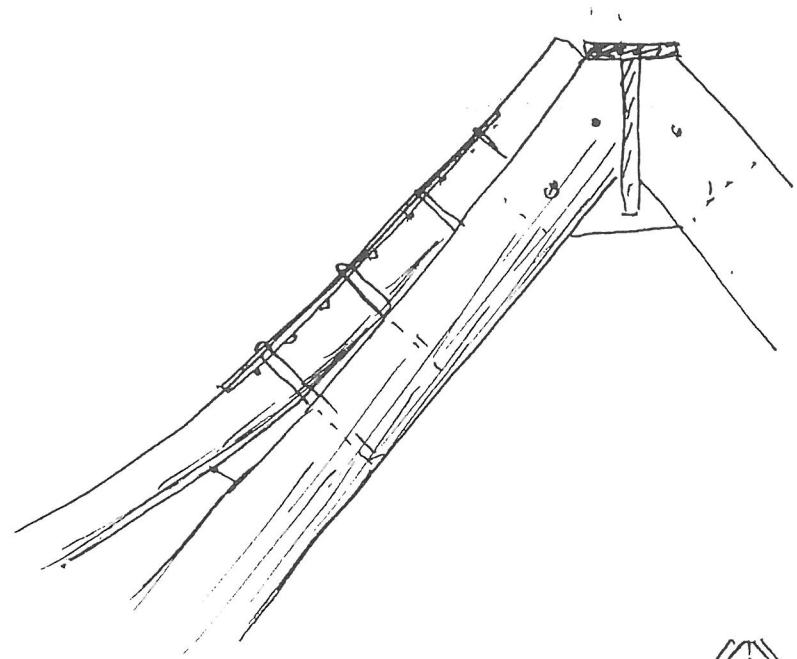

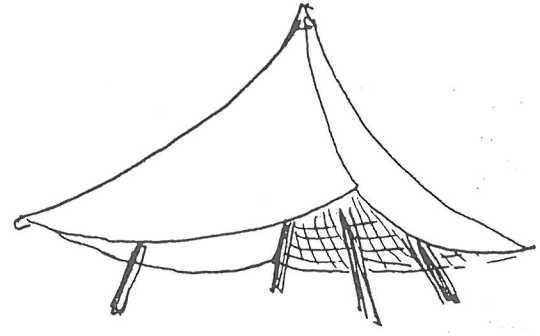
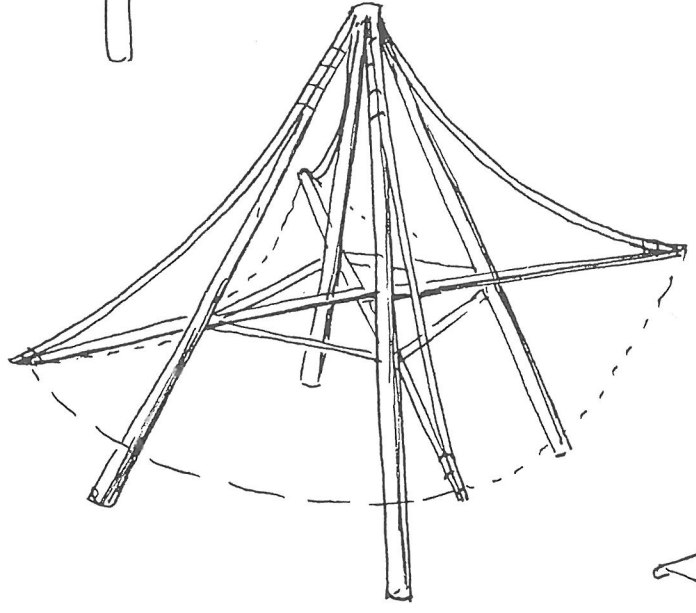
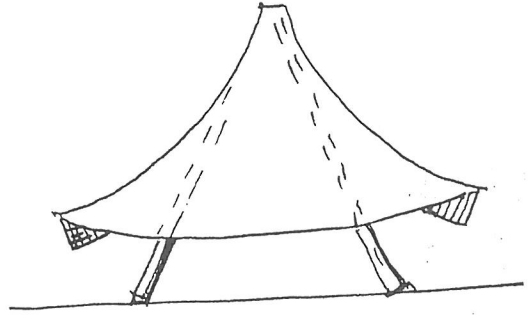
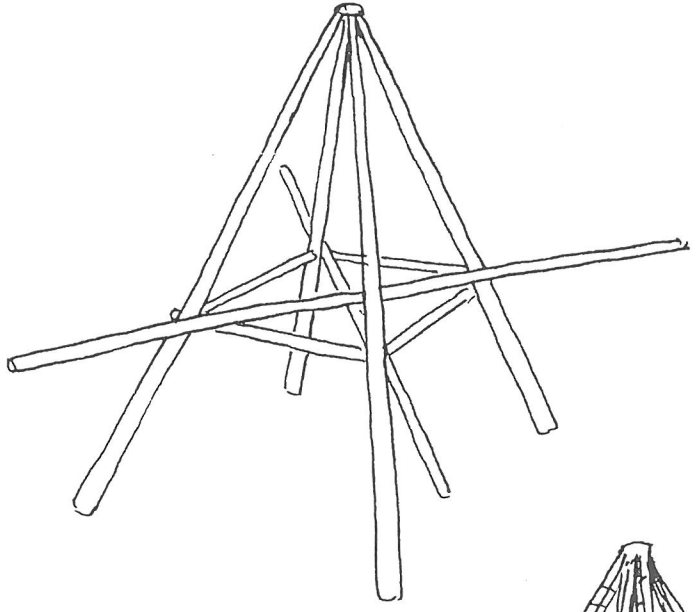

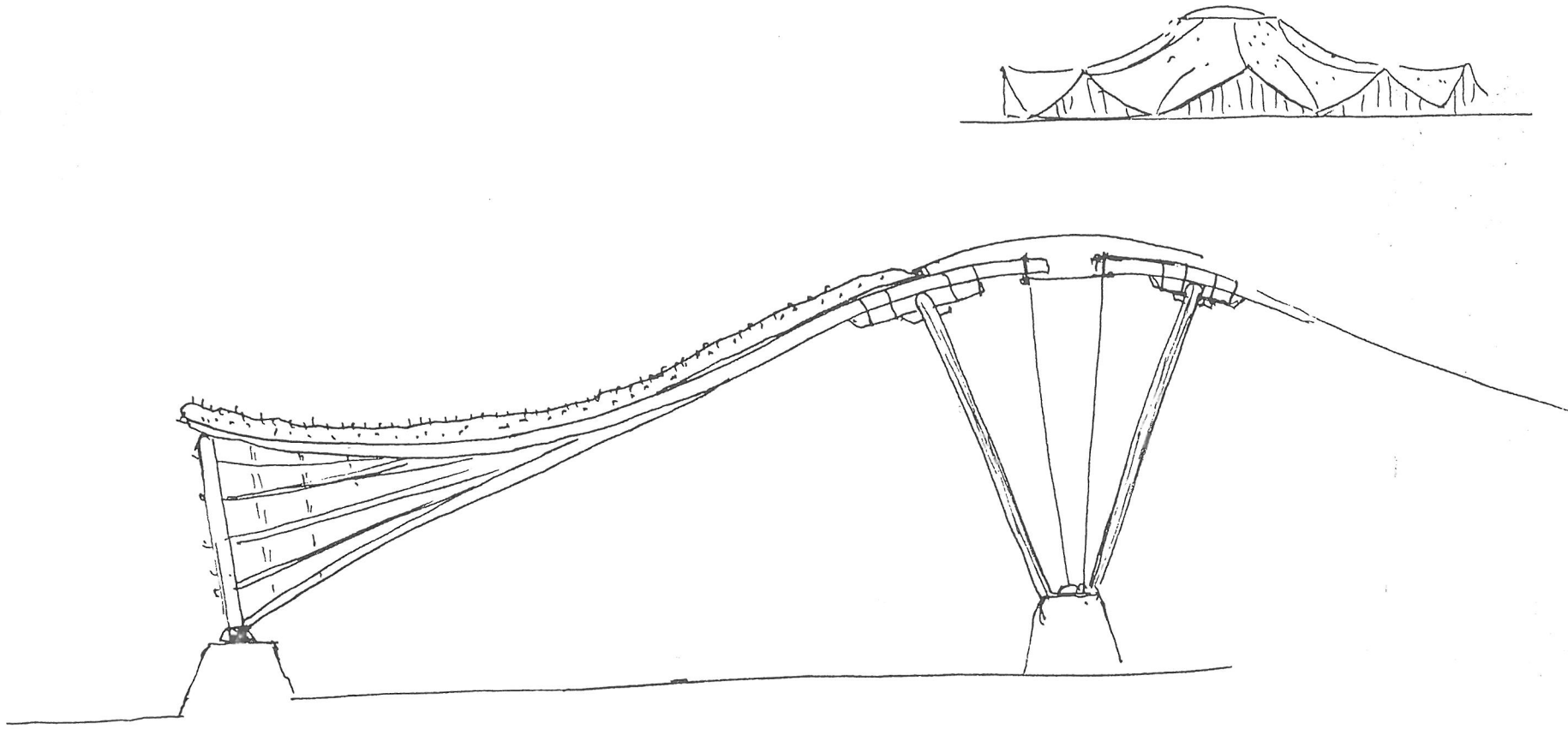

SPECIAL HOUSETYPES

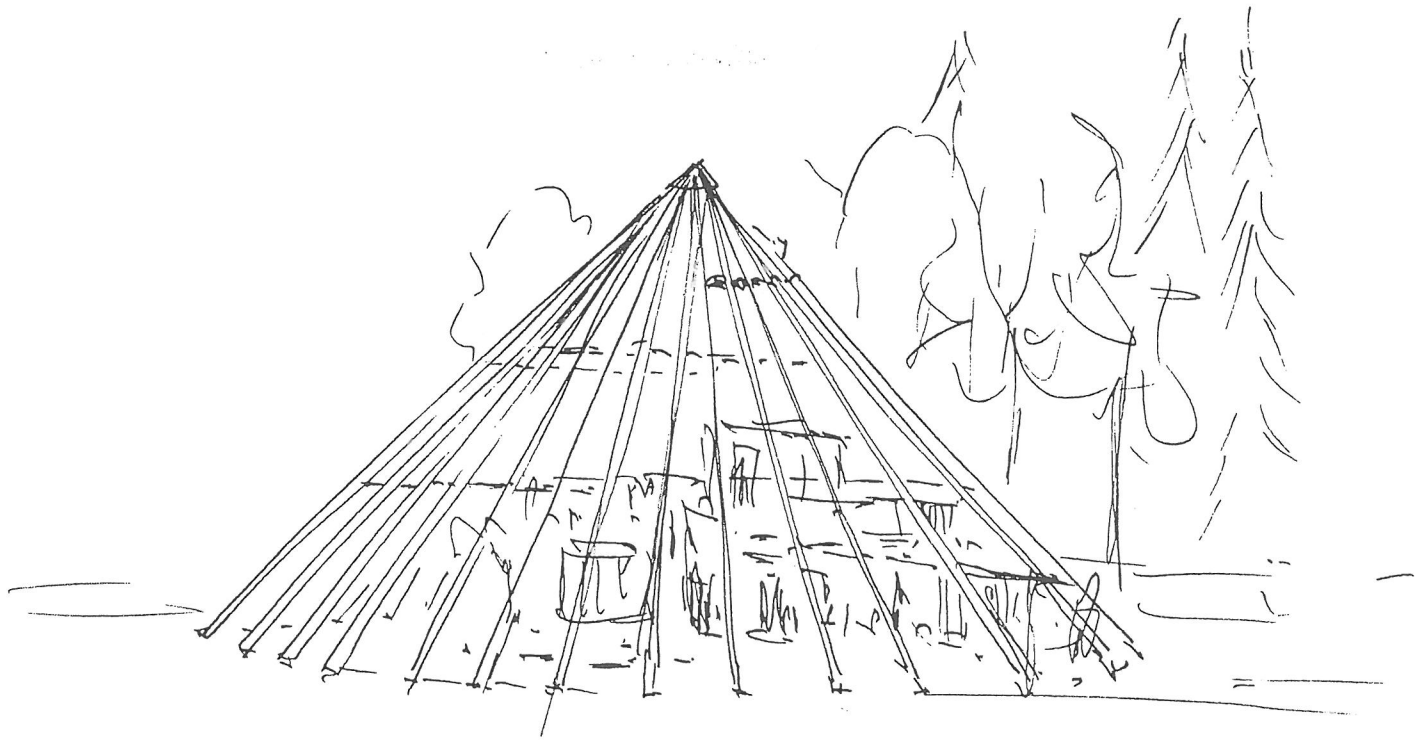

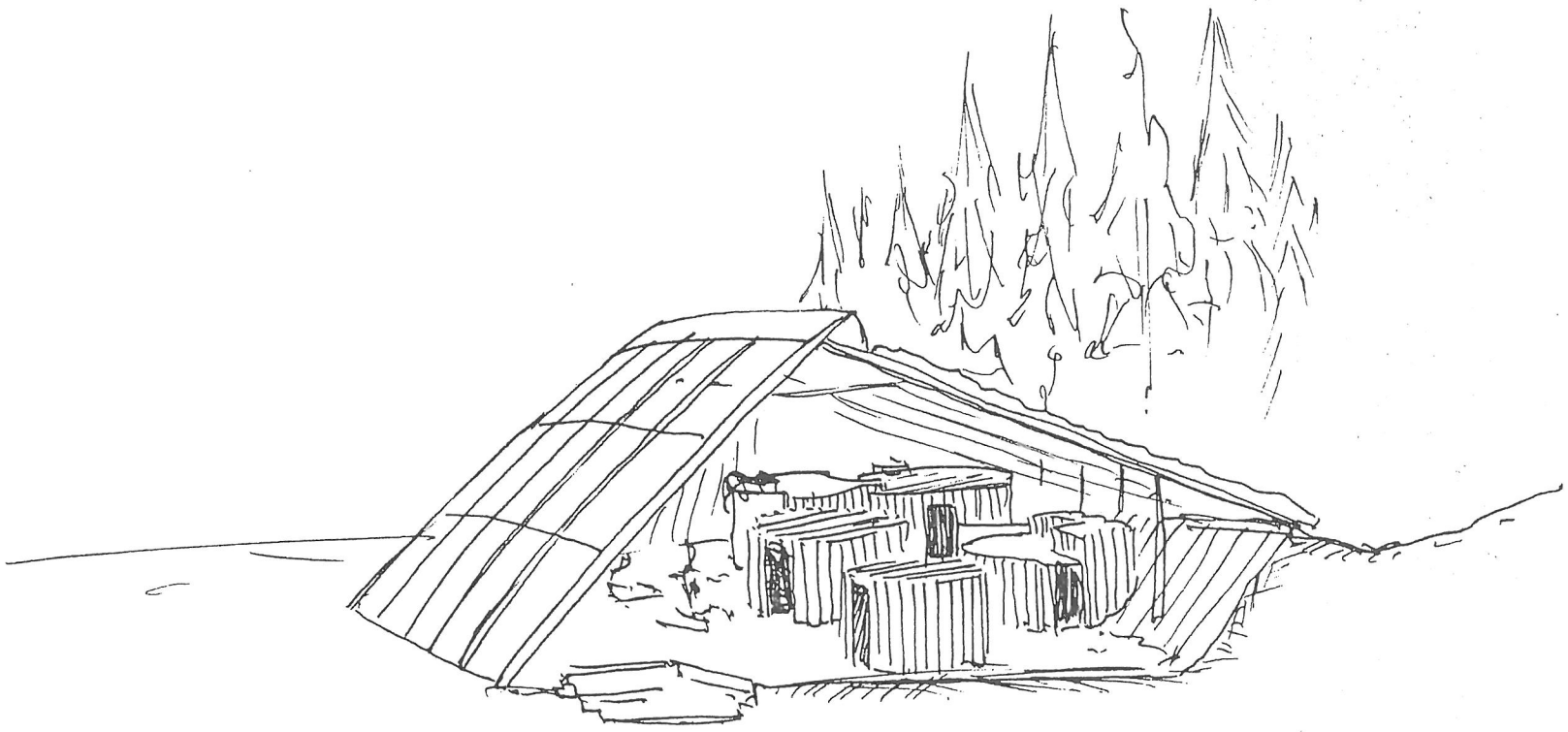

CART HOUSE

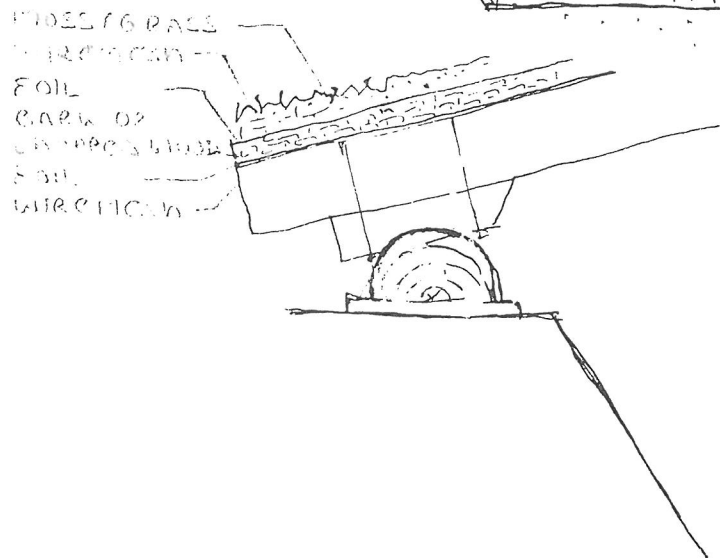
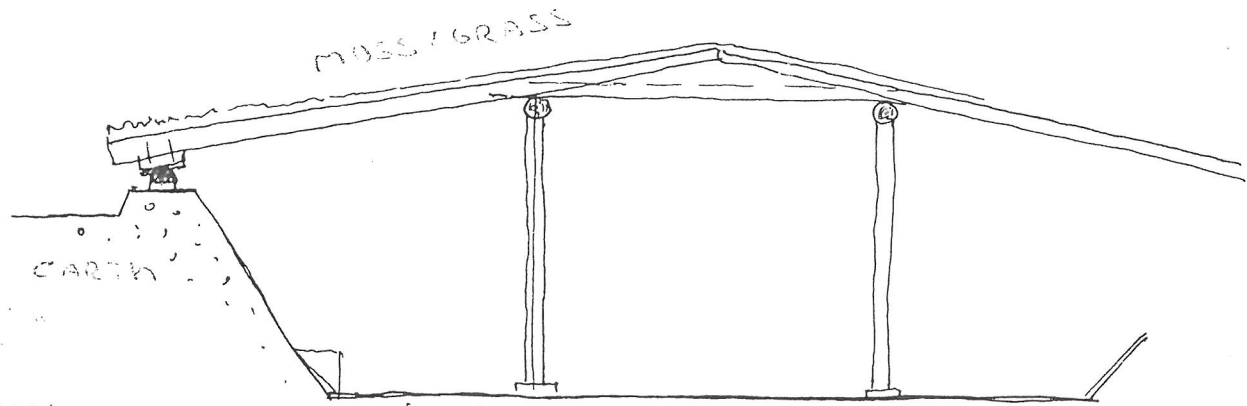

ATELIER FREI OT WARMBRONN - 7250 LEONBERG 7 BERG ULDE 19 07152 - 41084 (43908